

WILD FIRE

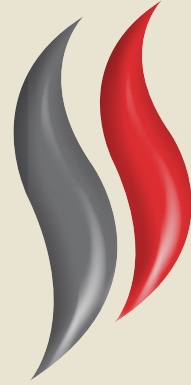

GAS & ELECTRIC APPLIANCES 2021/22

Exquisite fires for elegant homes

All about Wildfire	3	Open Fronted Gas Fires	
Gas Fires		Cavello	
Some things you need to know	4-5	<i>Full Depth Open Fronted</i>	44-45
Function and Performance	6-7	Montese (Cadiz Suite)	
		<i>Radiant full Depth Open Fronted</i>	46-47
High Efficiency (Glass Fronted) Gas Fires		Ceralis (Salerno suite)	
HE900 (Avellino Suite)		<i>Radiant Open Fronted for Precast Flues</i>	48-49
<i>for standard and precast flues</i>	8-9	Ellipsis (HIW / Hearth Mount)	
HE900 (Dawin Suite)		<i>A range of options featuring the Ellipsis trim</i>	50-51
<i>for standard and precast flues</i>	10-11		
HE950L (Seville Suite)		Gas Stoves	
<i>for standard and precast flues</i>	12-13	Ravel Gas Stove	
HE950L (Palma Suite)		<i>for standard and precast flues</i>	52-53
<i>for standard and precast flues</i>	14-15		
Ravel 600 (Asti 600 Suite) Limestone		Trim Options & Technical Information for Gas Fires	
<i>for standard flues</i>	16-17	Trim Options	
Ravel 600 (Amalfi Suite) Micro Marble		<i>Choose a trim for your Gas Fire</i>	54
<i>for standard flues</i>	18-19	Technical information for all gas appliances	55
Ravel 600 HIW Gas Fire			
<i>for standard flues</i>	20-21	Electric Fires	
Ravel 800 (Asti 800 Suite) Limestone		Some things you need to know	56-57
<i>for standard flues</i>	22-23		
Ravel 800 (Siena Suite) Micro Marble		Electric Fireplace Suites	
<i>for standard flues</i>	24-25	HE900E (Avellino Suite)	
Ravel 800 (HIW)		<i>for Flat Wall installation</i>	58-59
<i>for standard flues</i>	26-27	HE950LE (Seville Suite)	
Ravel 750 (Asti 750 Suite) Limestone		<i>for Flat Wall installation</i>	60-61
<i>for standard flues</i>	28-29	HE950LE (Palma Suite)	
Ravel 750 (Valentia Suite) Micro Marble		<i>for Flat Wall installation</i>	62-63
<i>for standard flues</i>	30-31	Panama E22 Widescreen (Avellino Suite)	
Panama HE (Salvador Suite)		<i>for Flat Wall installation</i>	64-65
<i>for standard flues</i>	32-33	Panama E22 (Salvador Suite)	
Cressida HE		<i>Widescreen Electric Fireplace</i>	66-67
<i>for standard flues</i>	34-35	Ravel E16 (Salvador Suite)	
Pesaro HE slimline		<i>16x22 Electric Fireplace</i>	68-69
<i>for standard and precast flues</i>	36-37		
Ravel HE (Salvador Suite)		Trim Options & Technical Information for Electric Fires	
<i>16" x 22" Log fire for standard flues</i>	38-39	Trim Options	
		<i>Choose a trim for your Electric Fire</i>	70
High Efficiency (Balanced Flue—No Chimney) Gas Fires		Fireplace dimensions for all Electric Fireplace Suites	71
Thermes			
<i>16" x 22" Balanced Flue Gas Fire</i>	40-41		
BF960SL (Hole in the Wall)			
<i>Landscape Balanced Flue Gas Fire</i>	42-43		



Exquisite fires for elegant homes

Wildfire are a multi award winning gas appliance manufacturer. The HE950L Seville Suite was named not only Gas fireplace suite of the year, but also 'Product of the Year' at the 2018 Hearth and Home exhibition.

Wildfire are dedicated to the design and manufacture of innovative and attractive fireplaces for British homes. At Wildfire we are committed to providing the highest quality heating products with a proven performance. Our innovative range of gas and electric fireplace suites have been tested to comply with the latest British and European standards and are manufactured in an ISO certified factory.

New for the 2021/2022 heating season is a beautiful range of gas fireplace suites featuring the Ravel 600/750/800. The Stunning new Ravel Stove is also now available, contact your dealer for a demonstration.

The Wildfire gas product range includes many products which have been designed and approved with efficiency at their core. In a world where energy costs have soared we believe it is important to obtain the absolute maximum from your heating appliance. With this in mind the net efficiency of Wildfire open fronted gas fires are up to 62% and the glass fronted fires up to 87.2%. So when you purchase a Wildfire heating product you can be confident that you will be installing a product that will deliver in all installation scenarios. Here at Wildfire we are devoted to innovative design whilst maintaining maximum functionality. All Wildfire slide control gas fires feature the latest patented Direct Slide technology.

Wildfire is the premier gas and electric appliance brand from Hearth Products Limited. Hearth Products has been actively involved in design and technology for the fireplace industry across the globe since 2003. Our product technologies have been used in products across Europe, Australia and North America.

Some things you need to know

Do I need a Convector or a Radiant Gas Fire?

It is important to know the difference between Radiant heat and Convected heat.

Radiant heat. In short, Radiant heat is emitted from all Wildfire appliances. This type of heat is actually infrared and heats objects in the room. Radiant heat is considered to be the most comfortable and natural form of heat.

Convected heat warms the air in the room. By passing the cooler air which enters the appliance at the bottom, through a heat exchanger, it warms up, then emits the hotter air back into the room from the top of the appliance.

Do I need a Glass Fronted Gas Fire?

A glass fronted fire will be more efficient and therefore more cost effective to run. Glass fronted appliances are usually more expensive to buy.

In general terms, it is usually more cost effective to purchase a glass fronted appliance if it is to be used more regularly as the efficiency savings will provide a quicker payback for the more expensive appliance. It is also important to remember that a glass fronted appliance will normally provide a similar amount of heat to an open fronted appliance, however, as it is more efficient, it is cheaper to run.



We guarantee our gas fire products for a period of 5 years from installation and our customer service staff are always on hand to help you with any query you may have with your product.*

Our 5 year limited guarantee is managed directly by Wildfire through our extensive network of service centres throughout the UK. Choose Wildfire for style, performance, reliability, value and peace of mind.*



Brick Chimney



Pre-Fabricated



Pre-Cast

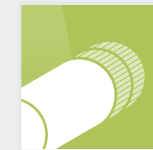

Balanced Flue

What type of flue do I have?

You will need to know what type of flue you have in your home. You will see these icons on each product page which will show if the appliance is suitable for your property. It may be that you have a Brick Chimney (otherwise known as a Class 1 flue), a Pre-Fabricated Metal System (which can be a Class 1 or Class 2 flue) or a Pre-Cast Flue (a flue which is built into the inner brickwork of your home). If you do not have a chimney or flue system in your home then you will need to look for a balanced flue gas fire which, if you already have a balanced flue gas fire in the property, is usually indicated by a flue terminal concealed within a basket on the outside of the property.



Manual Control



Slide Control



Manual Electronic Control

What control options are available?

All Wildfire products are available with a Direct Slide option giving you the ease of reliable and simple operation. The slide is operated from the top right side of the appliance and provides ignition, flame control and turns the fire off when you're finished. Most of the Wildfire range is available in manual control too – these fires have a removable cover at the base of the fire where the rotary control and igniter are situated.

Wildfire are also now introducing the manual electronic ignition to make the manual control range even easier to use.



Natural Gas

What type of gas do I need?

Wildfire appliances are currently only available for natural gas.

Function & Performance

O.D.S

The Oxygen Depletion Sensor will automatically shut off the gas supply to the burner if the oxygen level in the room falls below a particular level. This is important as it will turn off the appliance should the flue become blocked or a lack of ventilation occurs.

F.S.D

The Flame Supervision Device is designed to sense the presence of a flame. Should the flame be extinguished for any reason then the safety device will cut off the supply of gas to the burner.

Optional Ezi-Grip Handle

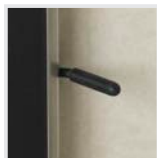

Most Wildfire appliances can be fitted with an elderly/infirm handle to ease the lighting operation. This larger handle is much easier to access and move so if you think that this may be a requirement then talk to your retailer who will demonstrate the Ezi-Grip system. This handle is purchased as an accessory and is fitted at the point of installation of the appliance.

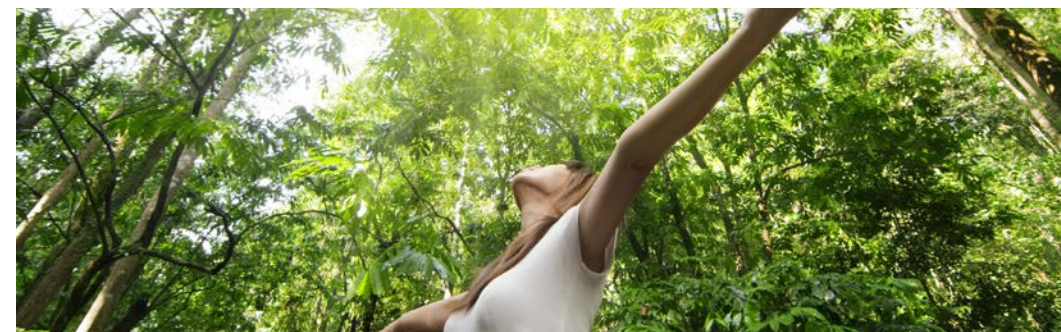
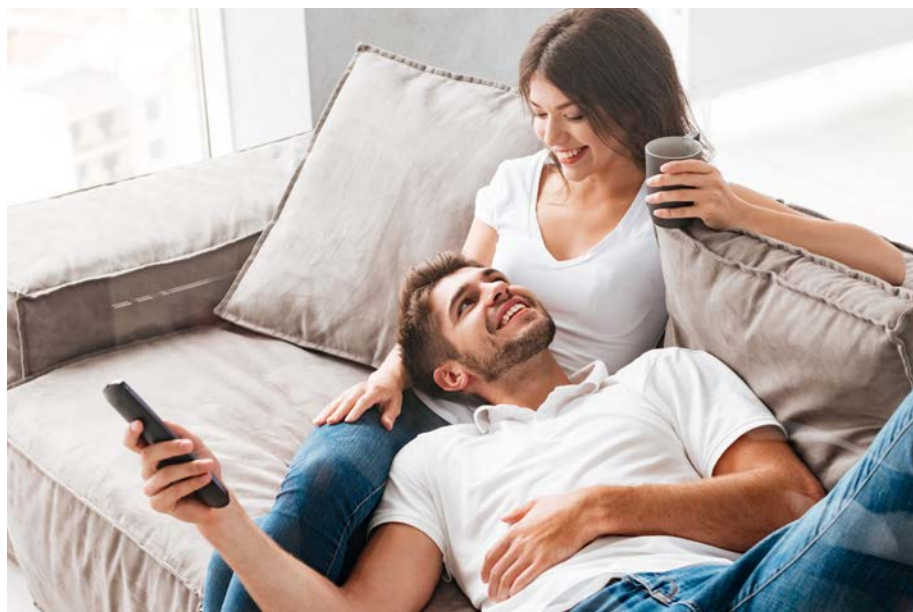

The Wildfire range is proud to now include a range of glass fronted high efficiency gas fires. These products feature the latest technology in high output gas fires and deliver the most effective way of heating your living room. The range includes both mid-depth convector and full depth convector products, both available with Direct Slide Technology. The Cressida (full depth) appliance can also be installed into a hole in the wall by fitting the designer Ellipsis HIW trim (See pages 40 and 41). The balanced flue gas fire is also a high efficient appliance, for a no chimney solution, the Thermes delivers heat, value for money, efficiency and is available with a large range of trim options.



Open fronted appliances are designed to operate with the revolutionary XE system which is only available from Hearth Products. This new efficiency system is designed to 'tune' the appliance to your fireplace flue, thereby ensuring you obtain the maximum output from the appliance.



Regulations demand that gas fires must be installed by a Registered Gas Safe Engineer. For further information regarding Gas Safe requirements contact Wildfire directly, where we will be happy to give you advice. Warranty will be void if the appliance is not fitted in accordance to these legal requirements.

HE 900 (Avellino Suite)



HE

Shown as standard version. Also available for Precast Flue.

83% EFFICIENCY

The HE900 is the flagship model from Wildfire, the ultimate in fireplace technology.

The HE900 gas fire is revolutionary. It has been developed to create a European format appliance with expansive viewing glass that can be installed into a conventional 16" x 22" fireplace opening without any modification, or precast flue where the PCF version is ordered. This patent pending product is designed to fit UK fireplace openings with no need to alter the fabric of the building.

The HE900 features a stunning log and ember bed, easily controlled with a slide operating system which comes as standard. Finally, the ultimate fireplace solution has arrived...

The Avellino micro marble suite is available in manila, white or white with grey border.

DIMENSIONS

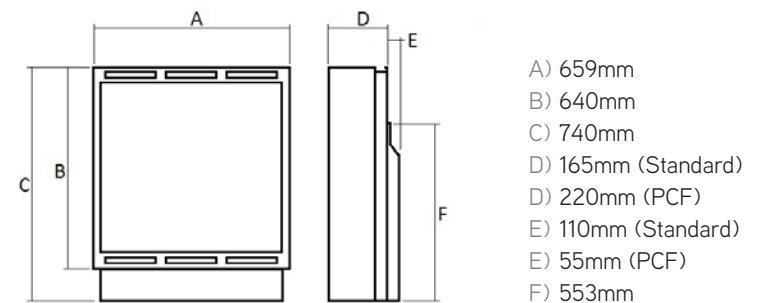

MANTEL DIMENSIONS

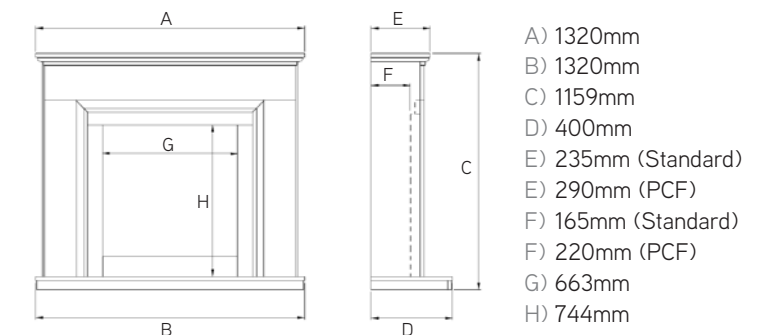

FLUE OPTIONS



Brick Chimney Pre-Fabricated *Pre-Cast

*When ordered as PCF model

CONTROL



Slide

FUEL BED



Log

FUEL



Natural Gas

STANDARD MANTEL FINISH OPTIONS

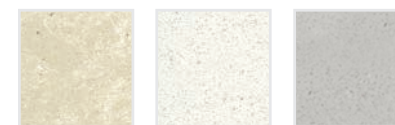

Manila White Grey

Available with grey inner border - see similar detail on the Seville Suite - page 12.

GAS CONSUMPTION

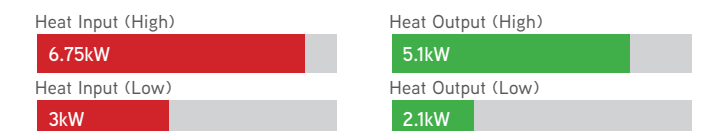

ENERGY EFFICIENCY CLASS D

HE 900 (Dawin Suite)

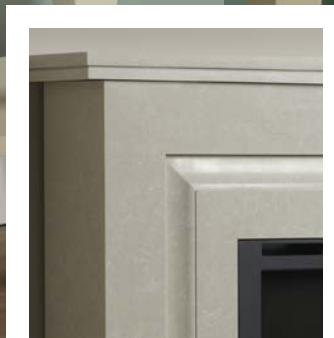

The HE900 (Pre-cast Flue) featured in the Dawin Suite (PCF) in Manila. Also available as Standard model. Inset Dawin Suite standard.



The HE900 is available with the Dawin Suite, shown here as a PCF version is a stylish solution for homes with precast flue systems.

No longer are you restricted to choosing a narrow slimline fire for your precast flue. After years of development, innovation and patent applications the precast gas fire market has changed.

Ask your retailer to demonstrate this wonderful appliance, with its clean European styling, stunning log and flame ensemble with easy slide for ignition and control, nothing compares.

The Dawin suite completes this inspirational fireplace. The warmest and most welcome addition to your living room. Experience the future with the HE900PCF...

DIMENSIONS

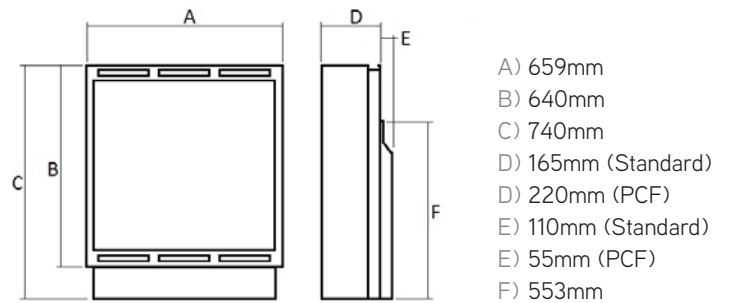

MANTEL DIMENSIONS

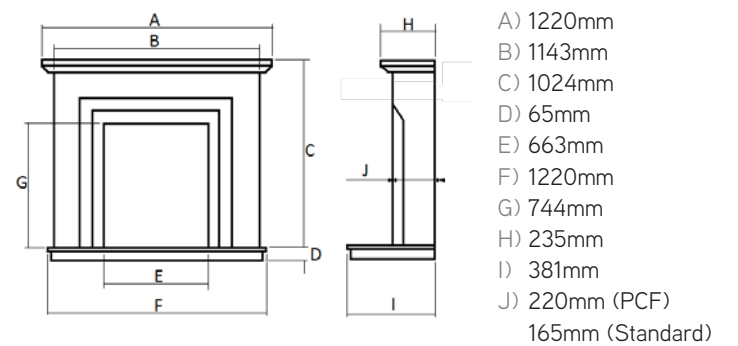

FLUE OPTION



Brick Chimney
Pre-Fabricated
*Pre-Cast
*When ordered as PCF model

CONTROL



Slide

FUEL BED



Log

FUEL



Natural Gas

STANDARD MANTEL FINISH OPTIONS



Manila White

GAS CONSUMPTION

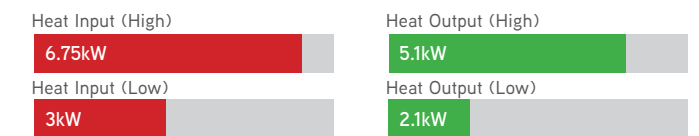

ENERGY EFFICIENCY CLASS D

HE 950L (Seville Suite)



HE

Shown as standard version. Also available for Precast Flue.

75%
EFFICIENCY

The new HE950L (STD & PCF) is the perfect appliance to bring your fireplace to life.

Just like the HE900, its predecessor, this fire fits into your standard 16" x 22" builders opening or precast flue if the PCF version is ordered. No building work, lintels, mess or costly installation. The fabric of your home will remain intact but you will benefit from a landscape, large format gas fire with beautifully crafted logs and colourful dancing flames. Ask your retailer for the different fireplace design options available with the HE950L, they will be able to deliver a suite to compliment the style of your living room.

DIMENSIONS

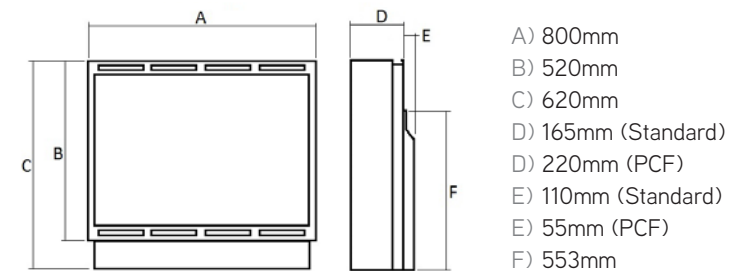

MANTEL DIMENSIONS

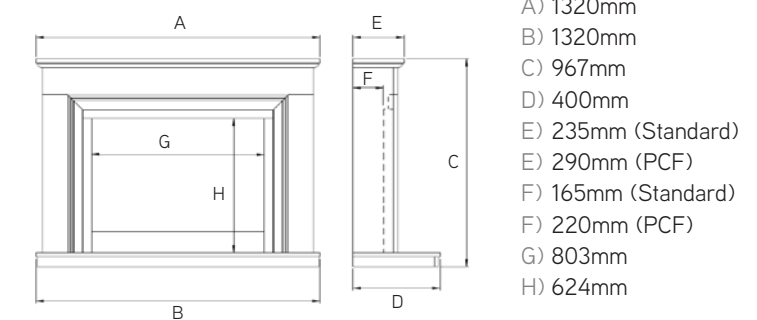

FLUE OPTIONS

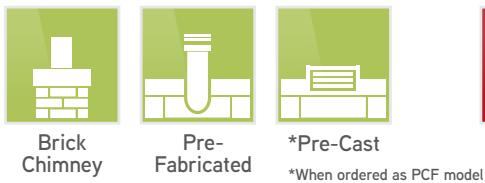

CONTROL



FUEL BED



FUEL



STANDARD MANTEL FINISH OPTIONS

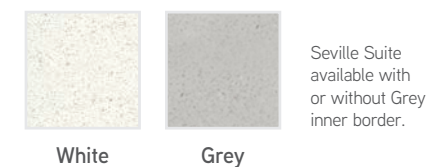

GAS CONSUMPTION

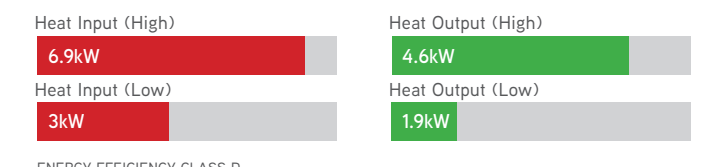

HE 950L (Palma Suite)



The new HE950L (STD & PCF) delivers the same benefits as the standard model but can be installed into any precast flue.

For too many years the gas fire options to customers who have precast flues have been extremely limited. Patent pending technology enables this product to work in these very small flues. This fire features a full width realistic log fuel bed with rolling flames guaranteed to captivate and mesmerise the most discerning home owner. Classic elegance...in a precast flue.

DIMENSIONS

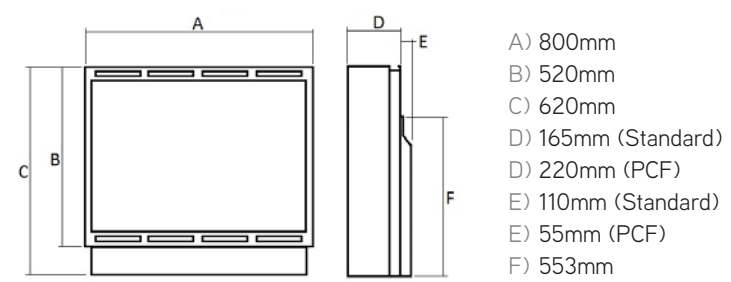

MANTEL DIMENSIONS

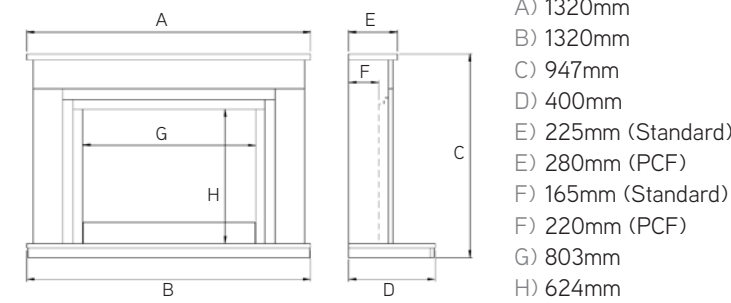

Shown as standard version. Also available for Precast Flue.



FLUE OPTION Brick Chimney Pre-Fabricated Pre-Cast <small>*When ordered as PCF model</small>			CONTROL Slide	FUEL BED Log	FUEL Natural Gas
--	--	--	-------------------------	------------------------	----------------------------

STANDARD MANTEL FINISH OPTIONS

Manila	White

GAS CONSUMPTION

Heat Input (High) 6.9kW	Heat Output (High) 4.6kW
Heat Input (Low) 3kW	Heat Output (Low) 1.9kW

ENERGY EFFICIENCY CLASS D

Ravel 600 (Asti 600 Suite) Limestone

NEW 2021



The Ravel 600 joins the family of Ravel products from Wildfire. This glass fronted gas fire is suitable for both class 1 and class 2 flues.

The Ravel 600 features the latest in under-log burner technology is sure to impress with its stunning fuel bed layout. The unique burner system allows the fire to be turned to low whilst still retaining an impressive flame picture.

Shown here in the Asti 600 Limestone surround, installed with the sleek Edge trim, for the trimless look. The Ravel 600 will fit nearly all masonry fireplace openings.

DIMENSIONS

EDGE

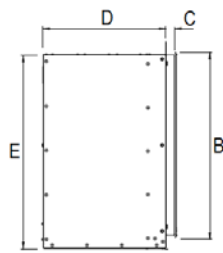
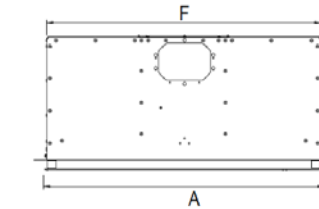

- A) 598mm
- B) 598mm
- C) 18-32mm
- D) 280mm
- E) 665mm
- F) 597mm

EDGE TRIM ONLY

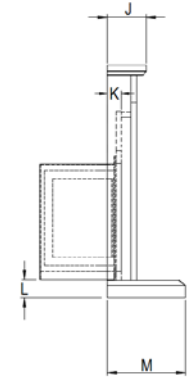
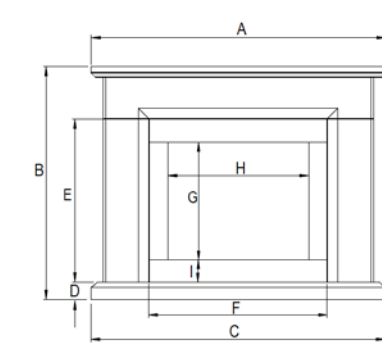

- A) 1210mm
- B) 1032mm
- C) 1220mm
- D) 60mm
- E) 742mm
- F) 780mm
- G) 590mm
- H) 588mm
- I) 72mm
- J) 145mm
- K) 45mm
- L) 60mm
- M) 380mm



Ravel 600 Edge trim, installed into the As 600 Limestone Suite



FLUE OPTIONS

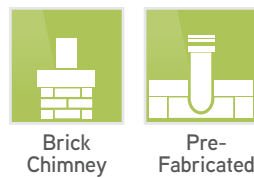

CONTROL



FUEL BED



FUEL



WATCH VIDEO



Scan QR Code

GAS CONSUMPTION

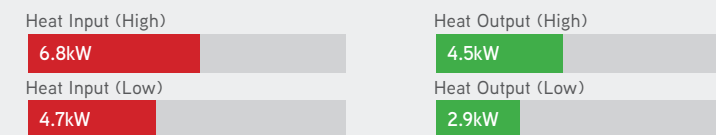

ENERGY EFFICIENCY CLASS E

Note: The Asti 600 Limestone suite is only available to suit the Edge style trim as shown.

Ravel 600
(Amalfi Suite)
Micro marble

NEW
2021

The Ravel 600 joins the family of Ravel products from Wildfire. This glass fronted gas fire is suitable for both class 1 and class 2 flues.

The Ravel 600 features the latest in under-log burner technology is sure to impress with its stunning fuel bed layout. The unique burner system allows the fire to be turned to low whilst still retaining an impressive flame picture.

Shown here in the Amalfi 600 micro marble surround, installed with the sleek Edge trim, for the trimless look. The Ravel 600 will fit nearly all masonry fireplace openings.

DIMENSIONS

EDGE

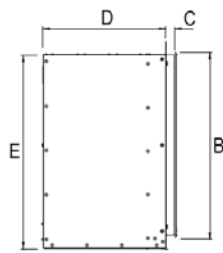
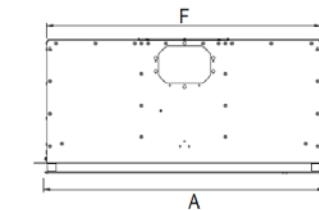

- A) 598mm
- B) 598mm
- C) 18-32mm
- D) 280mm
- E) 665mm
- F) 597mm

EDGE TRIM ONLY

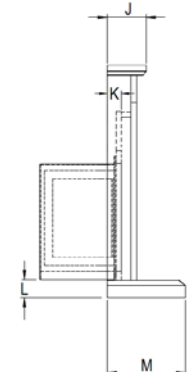
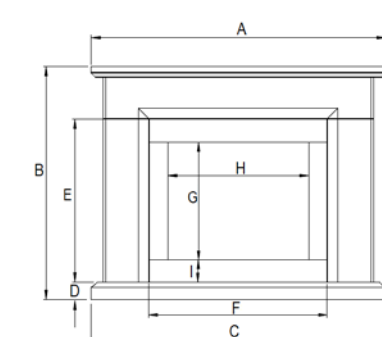

- A) 1210mm
- B) 1032mm
- C) 1220mm
- D) 60mm
- E) 742mm
- F) 780mm
- G) 590mm
- H) 588mm
- I) 72mm
- J) 145mm
- K) 45mm
- L) 60mm
- M) 380mm

HE

Ravel 600 Edge trim, installed into the Amalfi 600 micro marble Suite

74%
EFFICIENCY

FLUE OPTIONS

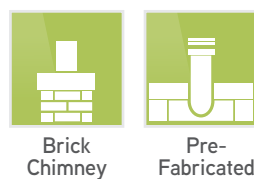

CONTROL



FUEL BED



FUEL



WATCH VIDEO



Scan QR Code

GAS CONSUMPTION

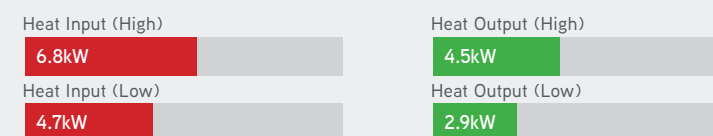

ENERGY EFFICIENCY CLASS E

Note: The Amalfi marble suite is only available to suit the Edge style trim as shown.

Ravel 600 HIW Gas Fire

NEW
2021



Ravel 600 Edge trim, installed as HIW.
Inset: Ravel 600 shown with standard (wide) trim.

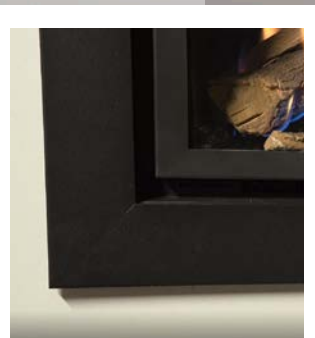

The Ravel 600 joins the family of Ravel products from Wildfire. This glass fronted gas fire is suitable for both class 1 and class 2 flues.

The Ravel 600 features the latest in under-log burner technology is sure to impress with its stunning fuel bed layout. The unique burner system allows the fire to be turned to low whilst still retaining an impressive flame picture.

Shown here installed as a Hole in the Wall fire with the sleek Edge trim, for the trimless look. The Ravel 600 will fit nearly all masonry fireplace openings.

DIMENSIONS

EDGE

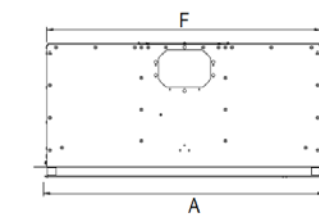

- A) 598mm
- B) 598mm
- C) 18-32mm
- D) 280mm

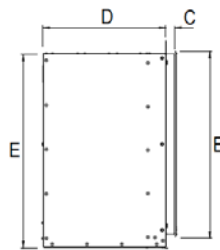

- E) 665mm
- F) 597mm

STANDARD

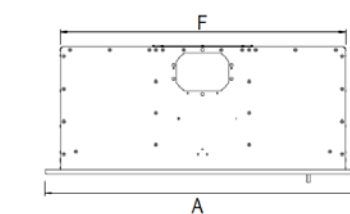

- A) 747mm
- B) 747mm
- C) 10mm
- D) 280mm

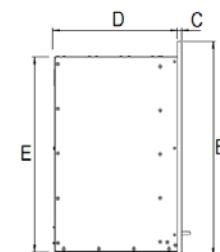

- E) 665mm
- F) 597mm



FLUE OPTIONS

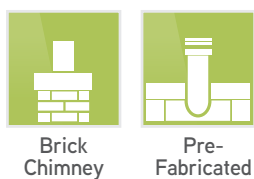

CONTROL



FUEL BED



FUEL



WATCH VIDEO



GAS CONSUMPTION

Heat Input (High)	6.8kW	Heat Output (High)	4.5kW
Heat Input (Low)	4.7kW	Heat Output (Low)	2.9kW

ENERGY EFFICIENCY CLASS E

Ravel 800

(Asti 800 Suite)
Limestone

NEW
2021



The Ravel 800 is one of the most exciting developments from Wildfire. This glass fronted gas fire is suitable for both class 1 and class 2 flues.

The Ravel 800 features the latest in under-log burner technology and is sure to impress with its stunning fuel bed layout.

The unique burner system allows the fire to be turned to low whilst still retaining an impressive flame picture.

Shown here in the Asti Limestone surround, this fire is available with two trim styles, the Edge trim, for the sleek trimless look or the conventional style Standard trim.

DIMENSIONS

EDGE

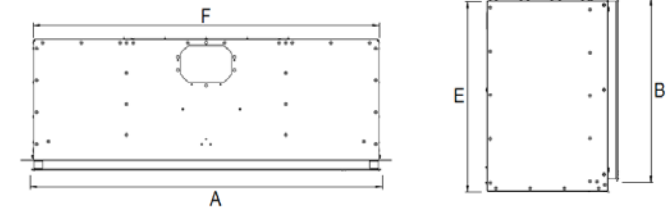

- A) 798mm
- B) 415mm
- C) 18-32mm
- D) 278mm
- E) 439mm
- F) 797mm

STANDARD

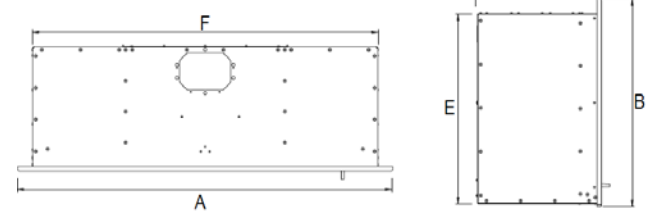

- A) 857mm
- B) 474mm
- C) 10mm
- D) 278mm
- E) 439mm
- F) 797mm

MANTEL DIMENSIONS

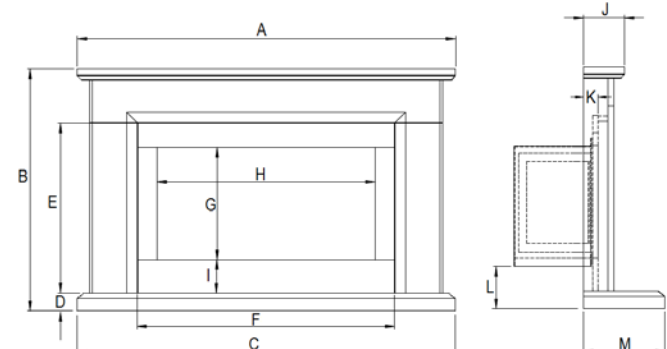

Ravel 800 Edge trim, installed into the Asti Limestone Suite. (Standard trim shown inset).



FLUE OPTIONS

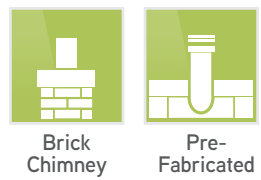

CONTROL



FUEL BED

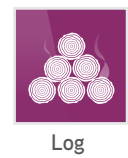

FUEL



WATCH VIDEO



Scan QR Code

GAS CONSUMPTION

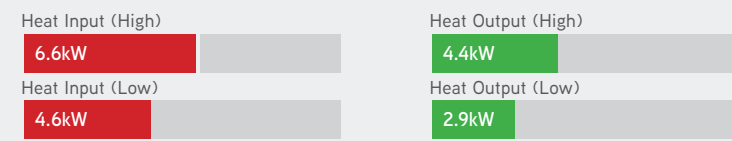

ENERGY EFFICIENCY CLASS E

- A) 1307mm
 - B) 864mm
 - C) 1307mm
 - D) 60mm
 - E) 594mm
 - F) 927mm
 - J) 140mm
 - K) 50mm
 - L) 155mm
 - M) 300mm
- EDGE TRIM**
- G) 406-408mm
 - H) 790-792mm
 - I) 124mm
- STANDARD TRIM**
- G) 444-446mm
 - H) 806-808mm
 - I) 95mm

Ravel 800
(Siena Suite)
Micro marble



NEW
2021

The Ravel 800 is one of the most exciting developments from Wildfire. This glass fronted gas fire is suitable for both class 1 and class 2 flues.

Shown here in the Siena Micro marble surround, this fire is available with two trim styles, the Edge trim, for the sleek trimless look or the conventional style Standard trim.

The Ravel 800 features the latest in under-log burner technology and is sure to impress with its stunning fuel bed layout. The unique burner system allows the fire to be turned to low whilst still retaining an impressive flame picture.

DIMENSIONS

EDGE

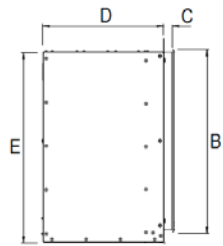
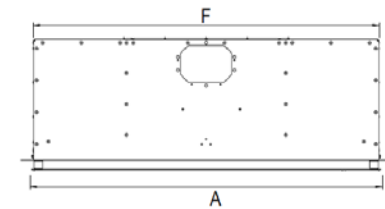

- A) 798mm
- B) 415mm
- C) 18-32mm
- D) 278mm
- E) 439mm
- F) 797mm

STANDARD

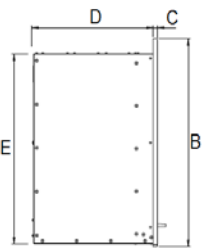
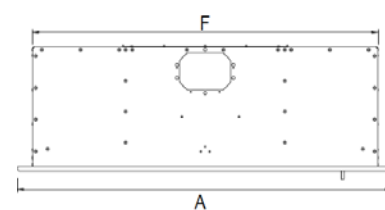

- A) 857mm
- B) 474mm
- C) 10mm
- D) 278mm
- E) 439mm
- F) 797mm

MANTEL DIMENSIONS

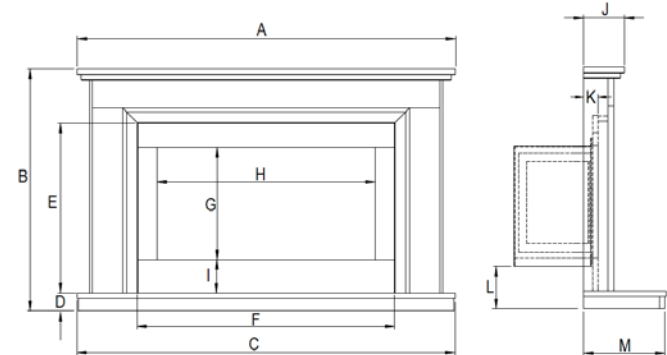

Ravel 800 Edge trim, installed into the Siena Marble Suite (Standard trim shown inset).



FLUE OPTIONS

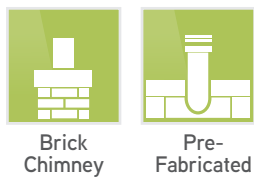

CONTROL



FUEL BED



FUEL



WATCH VIDEO



Scan QR Code

GAS CONSUMPTION

Heat Input (High)



Heat Input (Low)

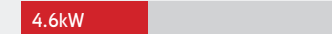

Heat Output (High)



Heat Output (Low)

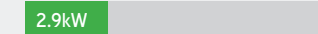

ENERGY EFFICIENCY CLASS E

- A) 1370mm
- B) 875mm
- C) 1370mm
- D) 65mm
- E) 614mm
- F) 928mm
- J) 145mm
- K) 50mm
- L) 155mm
- M) 300mm

EDGE TRIM

- G) 406-408mm
- H) 790-792mm
- I) 119mm

STANDARD TRIM

- G) 444-446mm
- H) 806-808mm
- I) 90mm

Ravel 800 (HIW)



NEW
2021

The Ravel 800 is one of the most exciting developments from Wildfire. This glass fronted gas fire is suitable for both class 1 and class 2 flues.

Shown here installed with the Ravel 800 Edge trim directly into a fireplace wall for a minimalistic look.

The Ravel 800 features the latest in under-log burner technology and is sure to impress with its stunning fuel bed layout. The unique burner system allows the fire to be turned to low whilst still retaining an impressive flame picture.

DIMENSIONS

EDGE

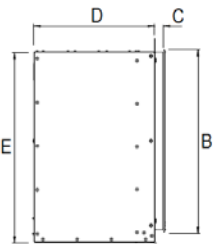
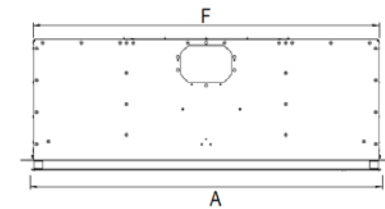

- A) 798mm
- B) 415mm
- C) 18-32mm
- D) 278mm
- E) 439mm
- F) 797mm

STANDARD

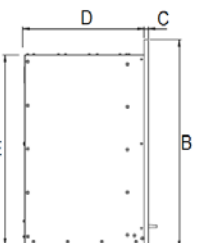
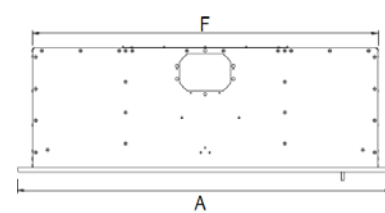

- A) 857mm
- B) 474mm
- C) 10mm
- D) 278mm
- E) 439mm
- F) 797mm



Ravel 800 Installed as 'Hole in the wall' with Edge trim, (Standard wider trim shown inset).



FLUE OPTIONS



Brick Chimney



Pre-Fabricated

CONTROL



Slide

FUEL BED



Log

FUEL



Natural Gas

WATCH VIDEO



Scan QR Code

GAS CONSUMPTION

Heat Input (High)	Heat Output (High)
6.6kW	4.4kW
Heat Input (Low)	Heat Output (Low)
4.6kW	2.9kW

ENERGY EFFICIENCY CLASS E

Ravel 750 (Asti 750 Suite) Limestone

NEW 2022



The Ravel 750 joins the family of Ravel products from Wildfire. This glass fronted gas fire is suitable for both class 1 and class 2 flues.

The Ravel 750 features the latest in under-log burner technology is sure to impress with its stunning fuel bed layout. The graceful and ingenious burner system allows the fire to be turned to low whilst still retaining an impressive flame picture.

Shown here in the Asti 750 Limestone surround, installed with the sleek Edge trim, for the trimless look. The Ravel 750 Asti suite is the culmination of years of research, development and manufacturing excellence, producing the ultimate gas log fire.

DIMENSIONS

EDGE

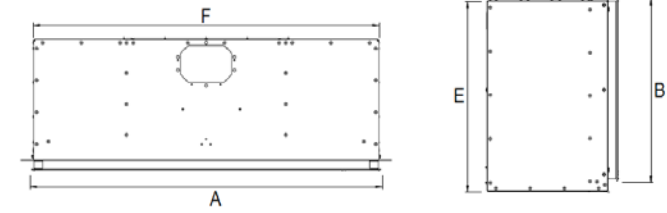

- A) 798mm
- B) 415mm
- C) 18-32mm
- D) 278mm
- E) 439mm
- F) 797mm

STANDARD

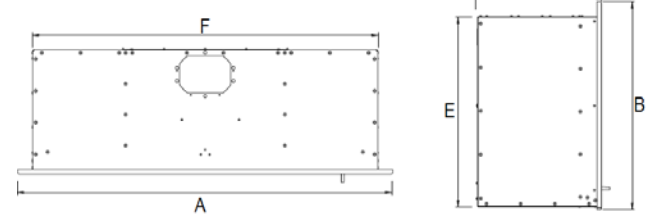

- A) 857mm
- B) 474mm
- C) 10mm
- D) 278mm
- E) 439mm
- F) 797mm

MANTEL DIMENSIONS

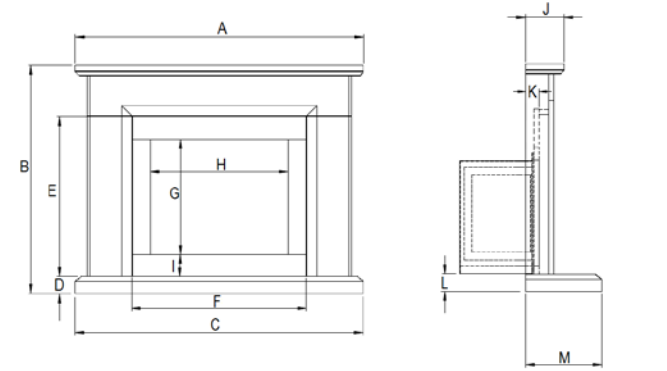

78% EFFICIENCY

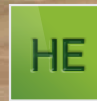

Ravel 750 Edge trim, installed into the Asti 750 Limestone Suite. Inset: Ravel 750 shown with standard (wide) trim.



FLUE OPTIONS

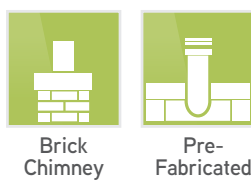

CONTROL



FUEL BED



FUEL



WATCH VIDEO



Scan QR Code

GAS CONSUMPTION

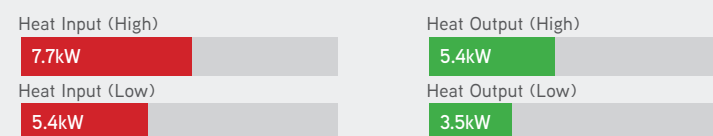

ENERGY EFFICIENCY CLASS E

- A) 1300mm
- B) 1120mm
- C) 1280mm
- D) 60mm
- E) 820mm
- F) 840mm
- J) 160mm
- K) 45mm
- L) 100mm
- M) 380mm

- EDGE TRIM**
- G) 702mm
 - H) 740mm
 - I) 70mm

- STANDARD TRIM**
- G) 741mm
 - H) 756mm
 - I) 40mm

Ravel 750

(Valentia Suite)
Micro marble

NEW
2022

The Ravel 750 joins the family of Ravel products from Wildfire. This glass fronted gas fire is suitable for both class 1 and class 2 flues.

The Ravel 750 features the latest in under-log burner technology is sure to impress with its stunning fuel bed layout. The graceful and ingenious burner system allows the fire to be turned to low whilst still retaining an impressive flame picture.

Shown here in the Valentia micro marble surround, installed with the sleek Edge trim, for the trimless look. The Ravel 750 Valentia suite is the culmination of years of research, development and manufacturing excellence, producing the ultimate gas log fire.

DIMENSIONS

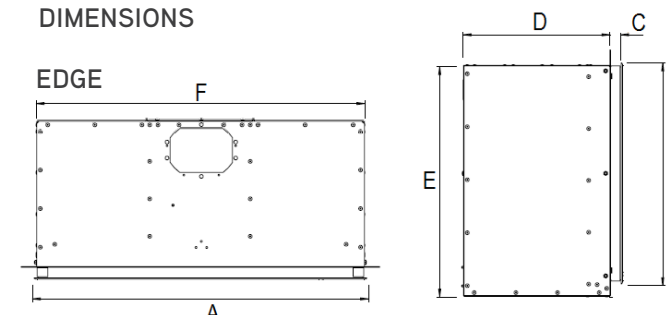

- A) 748mm
- B) 711mm
- C) 18-32mm
- D) 280mm
- E) 736mm
- F) 747mm

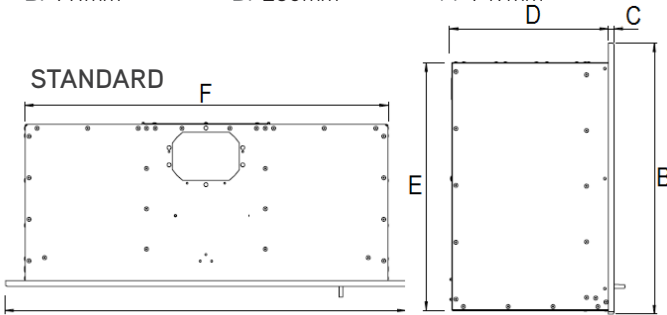

- A) 807mm
- B) 770mm
- C) 10mm
- D) 280mm
- E) 736mm
- F) 747mm

MANTEL DIMENSIONS - EDGE TRIM

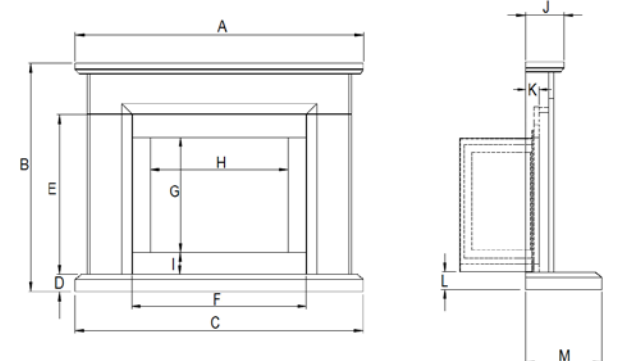

78%
EFFICIENCY

HE

Ravel 750 Edge trim, installed into the Valentia 750 micro marble Suite

FLUE OPTIONS

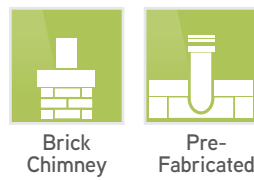

CONTROL



FUEL BED



FUEL



WATCH VIDEO



Scan QR Code

GAS CONSUMPTION

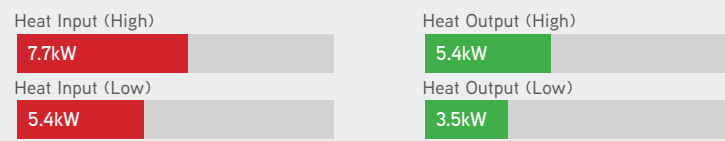

ENERGY EFFICIENCY CLASS E

- A) 1370mm
- B) 1150mm
- C) 1370mm
- D) 65mm
- E) 874mm
- F) 928mm
- G) 702mm
- H) 740mm
- I) 65mm
- J) 170mm
- K) 50mm
- L) 100mm
- M) 300mm

Note: The Valentia marble suite is only available to suit the Edge style trim as shown.

Panama HE (Salvador Suite)



HE

Panama HE shown with Contemporary Chrome/Black trim, installed into the Salvador suite in white.

This fire requires a fireplace suite with a 3" rebate and a back panel opening of a specific size. Talk to your retailer for full details.

87%
EFFICIENCY

The Panama log fire is a revolutionary product.

This wide format glass fronted gas appliance has the appeal of a European fire but the benefit of fitting into a standard 16" x 22" chimney breast opening. Normally an appliance of this stature would require building work and installation of a new lintel. The Panama has a patent pending installation system which, in conjunction with your new fireplace will provide a much more cost effective solution for this type of product. Talk to your dealer for full details. The Panama comes in slide control as standard.

DIMENSIONS

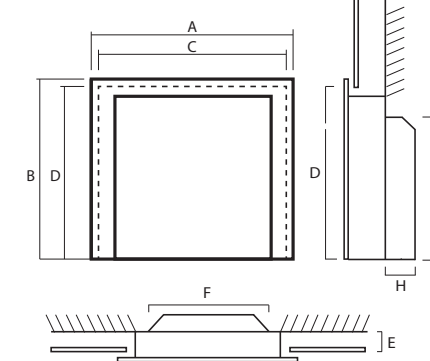

- A) 614mm Trim Width
- B) 611mm Trim Height
- C) 560mm-580mm Back Panel Opening Width
- D) 585mm-600mm Back Panel Opening Height
- E) 76mm Mantel Rebate
- F) 406mm Fire Width at Builders Opening
- G) 565mm Fire Height at Builders Opening
- H) 117mm Fire Depth into Builders Opening

MANTEL DIMENSIONS

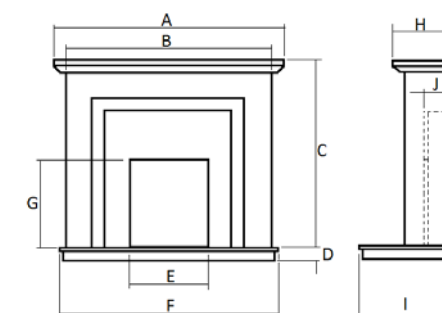

- A) 1370mm
- B) 1278mm
- C) 1095mm
- D) 65mm
- E) 570mm
- F) 1370mm
- G) 590mm
- H) 230mm
- I) 400mm
- J) 75mm

GAS CONSUMPTION

Heat Input (High)	Heat Output (High)
5.3kW	4.3kW
Heat Input (Low)	Heat Output (Low)
2.7kW	1.8kW

ENERGY EFFICIENCY CLASS C

FLUE OPTIONS

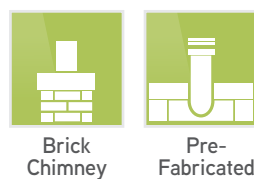

CONTROL



FUEL BED



FUEL



STANDARD MANTEL FINISH OPTIONS

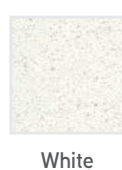

SLIDE LEVER OPTIONS



PANAMA TRIM OPTIONS



Cressida HE



The Cressida HE is a high efficiency glass fronted appliance suitable for Class 1 and Class 2 flues.

The most powerful gas fire in the Wildfire range, with its deep bed and powerful output this appliance provides the ultimate in performance and style.

The flagship Cressida HE is supplied in either manual or slide control. The slide control features the latest patent pending Direct Slide technology.

Remember, once you have chosen your appliance, you can decide how it looks by selecting trim and fret options. See the trim options below and in more detail on page 54..

DIMENSIONS

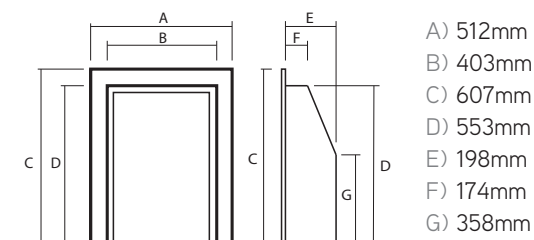

SLIDE LEVER OPTIONS



GAS CONSUMPTION

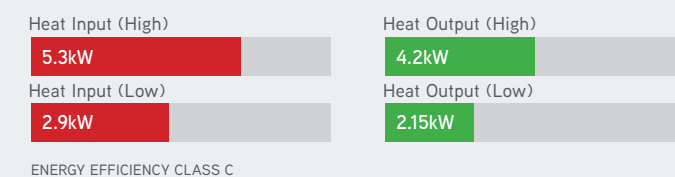

Cressida HE shown with Creative Contemporary Satin/Black trim.

FLUE OPTIONS

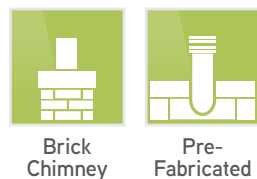

CONTROLS



FUEL BED



FUEL



STANDARD TRIM OPTIONS

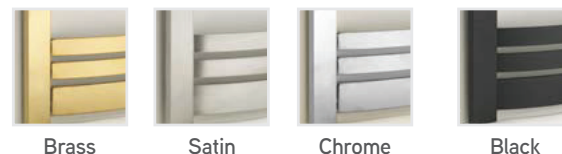

Front bars are optional. For more details see page 54

CREATIVE TRIM OPTIONS

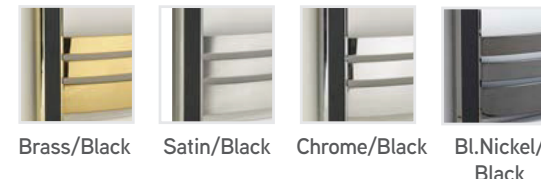

PROFILE TRIM OPTIONS

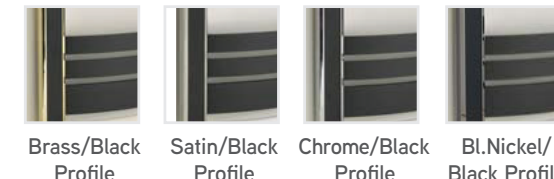

HE

Pesaro HE



HE

Pesaro HE shown with Chrome Contemporary trim.

84%
EFFICIENCY

The Pesaro HE is a high efficiency glass fronted appliance suitable for Precast, Class 1 and Class 2 flues.

When the most important factor is heat, then the Pesaro mid-depth high efficiency gas fire will deliver. The fire can be fitted with an additional spacer to reduce the effective depth of the appliance.

The Pesaro HE is available in slide control as standard.

DIMENSIONS

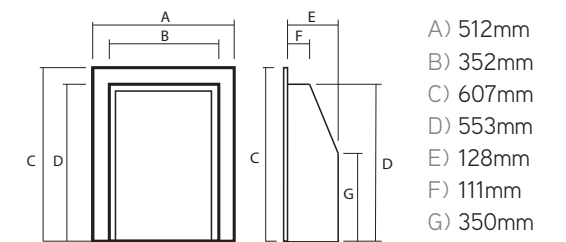

SLIDE LEVER OPTIONS

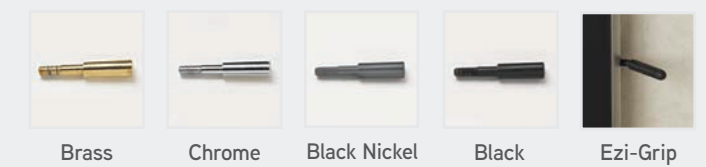

GAS CONSUMPTION

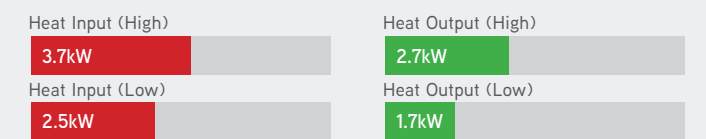

ENERGY EFFICIENCY CLASS D

FLUE OPTIONS



CONTROL



FUEL BED



FUEL



STANDARD TRIM OPTIONS

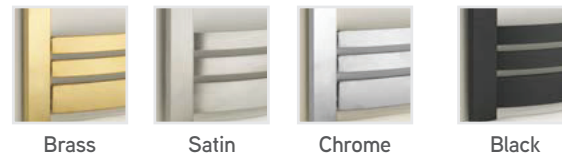

Front bars are optional. For more details see page 54

CREATIVE TRIM OPTIONS



PROFILE TRIM OPTIONS

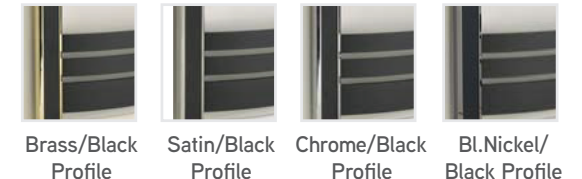

Ravel HE (Salvador Suite)



HE

Ravel HE Log shown with Black Nickel / Chrome trim, installed into the Salvador White Suite

The Ravel HE Log 16" x 22" is a high efficiency glass fronted fire suitable for class 1 and class 2 flues.

The Ravel HE Log is sure to impress, with its under log burners and stunning fuel bed layout. The unique burner system allows the fire to be turned to low whilst still retaining an impressive flame height.

This fire is available with two trim styles, the Black Nickel and Chrome or the striking Anthracite version.

DIMENSIONS

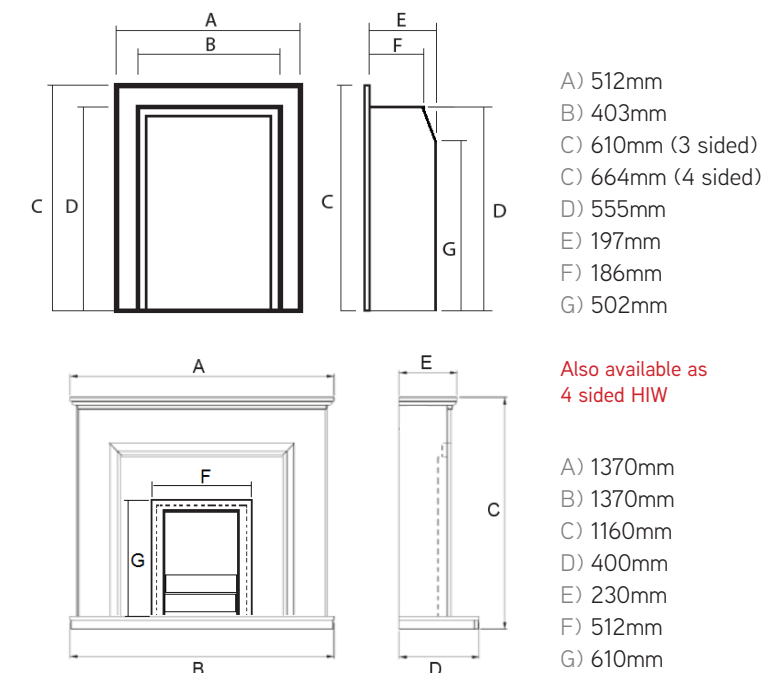

GAS CONSUMPTION

Heat Input (High)	4.8kW	Heat Output (High)	3.7kW
Heat Input (Low)	3.0kW	Heat Output (Low)	2.1kW

ENERGY EFFICIENCY CLASS C

FLUE OPTIONS

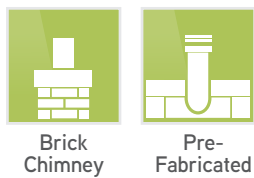

CONTROL



FUEL BED



FUEL



STANDARD MANTEL FINISH OPTIONS

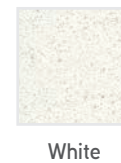

SLIDE LEVER OPTIONS



RAVEL TRIM OPTIONS

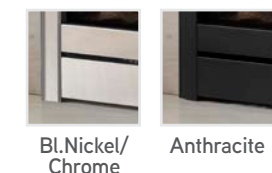

Thermes

Balanced Flue



“The balanced flue fire that really delivers”

The Thermes is our high efficiency balanced flue gas appliance.

If you have no flue or chimney in your home you will need a balanced flue gas fire. The Thermes is a room sealed high efficiency gas fire that really delivers.

This fire flues through an external wall and can be installed in most new or existing fireplaces.

Remember, once you have chosen your appliance, you can decide how it looks by selecting trim and fret options. See the trim options below and in more detail on page 54.

DIMENSIONS

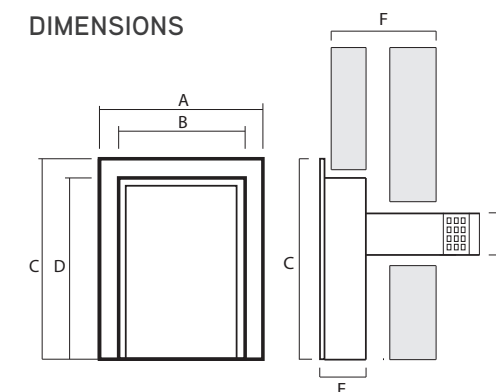

- A) 512mm
- B) 406mm
- C) 607mm
- D) 552mm
- E) 186mm
- F) 290-624mm
- G) 152mm

GAS CONSUMPTION

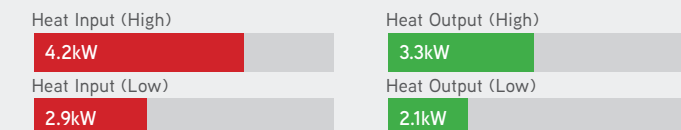

ENERGY EFFICIENCY CLASS C



HE

Thermes shown with Creative Profile Contemporary Satin/Black trim.

Featured with an Elgin & Hall Sophia 50" surround in Italcia Micro Marble

- FLUE OPTION**: Balanced Flue
- CONTROLS**: Manual Electronic, Slide
- FUEL BED**: Coal
- FUEL**: Natural Gas
- SLIDE LEVER**: Ezi-Grip
- STANDARD TRIM OPTIONS**: Brass, Satin, Chrome, Black
- CREATIVE TRIM OPTIONS**: Brass/Black, Satin/Black, Chrome/Black, Bl.Nickel/Black
- PROFILE TRIM OPTIONS**: Brass/Black Profile, Satin/Black Profile, Chrome/Black Profile, Bl.Nickel/Black Profile

Front bars are optional. For more details see page 54

BF960SL

Balanced Flue



The BF960SL balanced flue gas fire is suitable for homes without a chimney.

This versatile and efficient slimline hole in the wall fire can be installed onto any outside wall of the home and generates a contemporary and stylish centrepiece for the room. This appliance can be installed directly into a cavity wall yet provides probably the deepest fuel bed effect for a product of its type. Coupled with a reflective black glass lining, this gas fire delivers the ultimate dancing flame effect and ceramic log layout.

TRIM DIMENSIONS

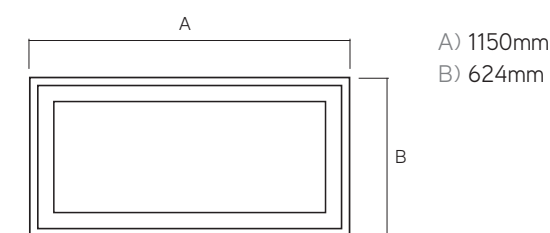

APPLIANCE DIMENSIONS

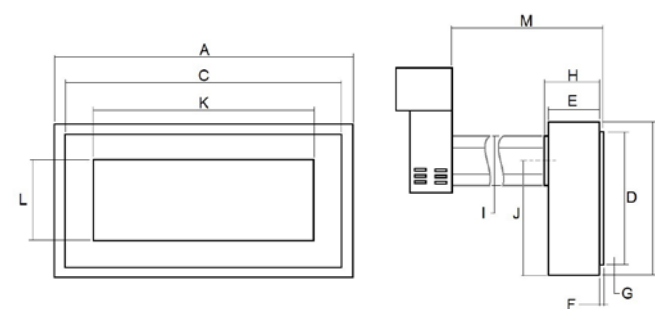

- A) 1198mm E) 174mm I) 151mm M) 270mm - 725mm
- B) 666mm F) 13mm J) 523mm
- C) 1138mm G) 29mm K) 862mm
- D) 608mm H) 183mm L) 332mm

HE

86%
EFFICIENCY

FLUE OPTION



Balanced Flue

CONTROLS



Slide

FUEL BED



Log

FUEL



Natural Gas

GAS CONSUMPTION

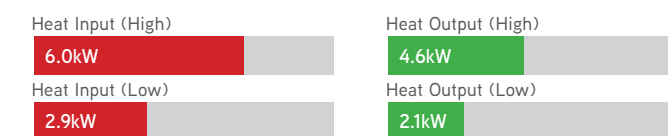

ENERGY EFFICIENCY CLASS C

Cavello XE



XE

Cavello XE shown with Brass/Black Contemporary Creative trim.

The Cavello XE is a realistic open fronted gas fire with a powerful convecting heat exchanger to boost performance.

The Cavello is supplied with the XE System as standard, see page 7 for more details. This convector appliance will produce enough heat to satisfy most of the largest living rooms. It is available in manual and slide control with options of coal and pebble fuel bed effects.

The Wildfire Cavello XE can be supplied with a range of trims to suit the style that you are trying to achieve. See full trim options on page 54.

DIMENSIONS

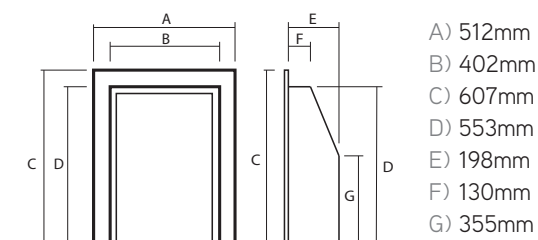

SLIDE LEVER OPTIONS



GAS CONSUMPTION

Heat Input (High)	Heat Output (High) (Manual Control)
6.75kW	3.8kW
Heat Input (Low) (Manual Control)	Heat Output (Low) (Manual Control)
3.5kW	1.8kW

ENERGY EFFICIENCY CLASS F

FLUE OPTIONS

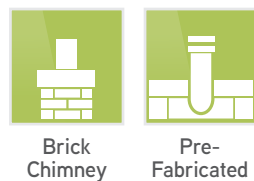

CONTROLS



FUEL BEDS

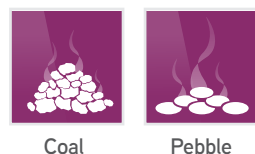

FUEL



STANDARD TRIM OPTIONS



Front bars are optional. For more details see page 54

CREATIVE TRIM OPTIONS

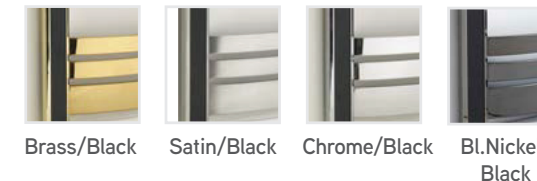

PROFILE TRIM OPTIONS

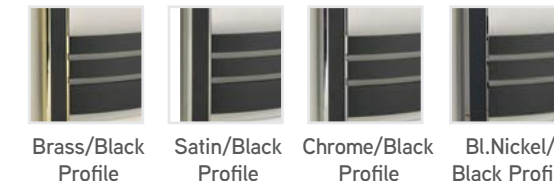

Montese (Cadiz Suite)



The Montese shown with Cadiz suite in white/Grey. Also shown in all white (inset). Cadiz suite available with or without lights.

Available as XE model with canopy see page 7 for further information.



The Montese is a stunning fire that will enhance any living room.

The Montese is an authentic looking coal effect gas fire, where realism is the most important factor.

By utilising the broad range of trims that Wildfire provides, you can choose the mood of your room from contemporary to traditional. It is available with pebble and coal fuel bed options and offers an impressive radiant heat output.

The Wildfire Montese is available in manual and slide control. See page 54 for full trim specifications.

DIMENSIONS

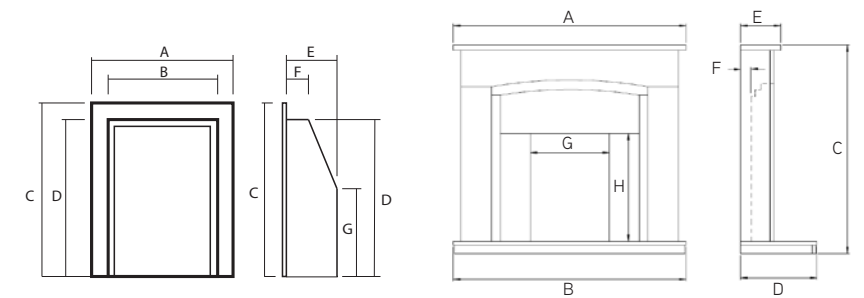

- A) 512mm D) 553mm G) 328mm A) 1220mm D) 400mm G) 413mm
- B) 403mm E) 173mm B) 1220mm E) 210mm H) 565mm
- C) 607mm F) 104mm C) 1095mm F) 45/75mm

SLIDE LEVER OPTIONS

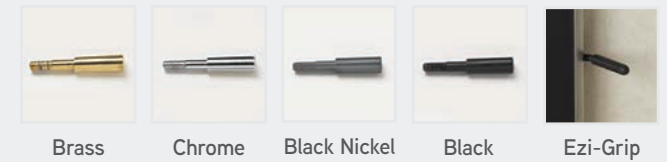

MANTEL

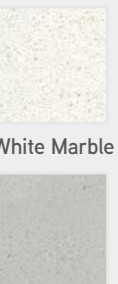

White Marble
Grey
Cadiz suite available with or without grey inner border.

GAS CONSUMPTION

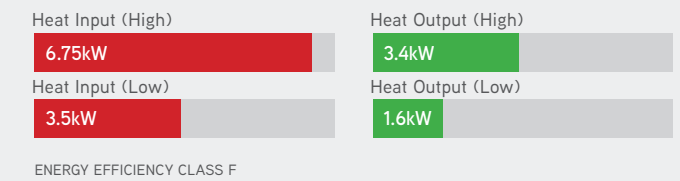

FLUE OPTIONS

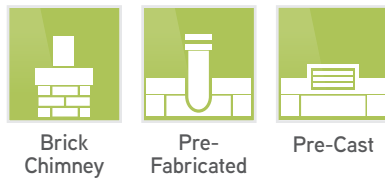

CONTROLS



FUEL BEDS



FUEL



STD. TRIM OPTIONS



Front bars are optional. For more details see page 54

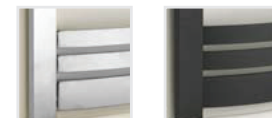

CREATIVE TRIM OPTIONS

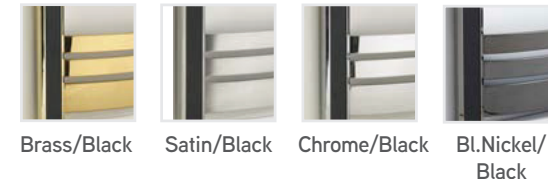

PROFILE TRIM OPTIONS



Ceralis (Salerno Suite)



The Ceralis shown with standard brass trim and Bauhaus fret. The Salerno mantel in all white. Also available in white/grey.

Available as XE model with canopy see page 7 for further information.



The Ceralis is a powerful slimline appliance that will fit into all flue types. A spacer is available to enable it to be fitted into shallow precast flues.

The realistic fuel bed boasts a powerful flame picture for its size making the Wildfire Ceralis the obvious option when the flue available limits your choice of fire.

The Ceralis is available in manual and slide control with coal and pebble fuel bed options. The slimline fire is a stunning appliance which makes it the first choice for your precast flue. For full trim options see page 54.

DIMENSIONS

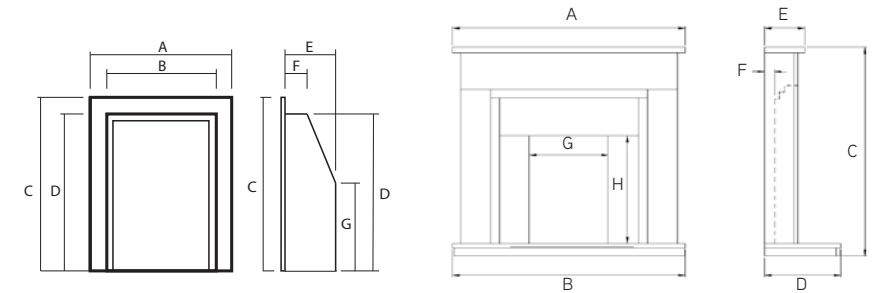

- A) 512mm
- B) 352mm
- C) 607mm
- D) 553mm
- E) 123mm
- F) 65mm
- G) 300mm

- A) 1220mm
- B) 1220mm
- C) 1095mm
- D) 400mm
- E) 210mm
- F) 45/75mm
- G) 413mm
- H) 565mm

SLIDE LEVER OPTIONS

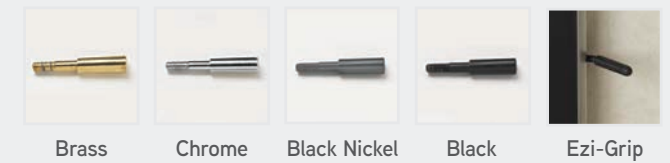

MANTEL

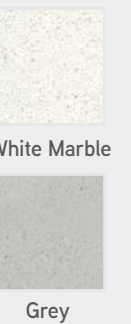

GAS CONSUMPTION

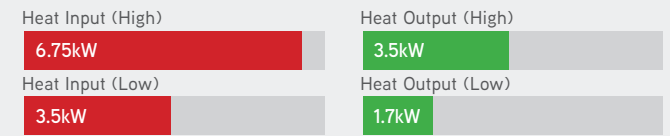

ENERGY EFFICIENCY CLASS F

Available with grey inner border. See similar detail on the Cadiz suite - page 48

FLUE OPTIONS

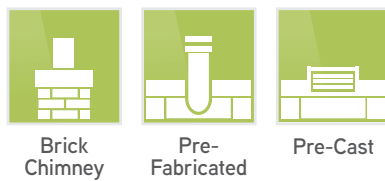

CONTROLS

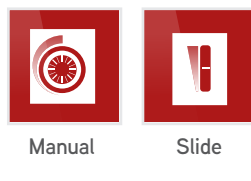

FUEL BEDS

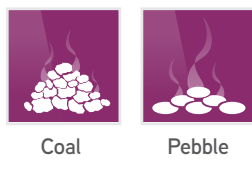

FUEL



STD. TRIM OPTIONS

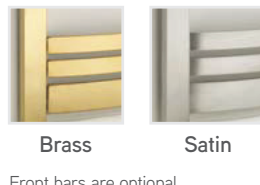

Front bars are optional. For more details see page 54

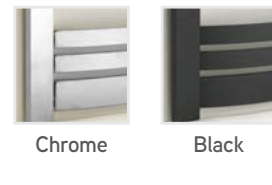

CREATIVE TRIM OPTIONS



PROFILE TRIM OPTIONS

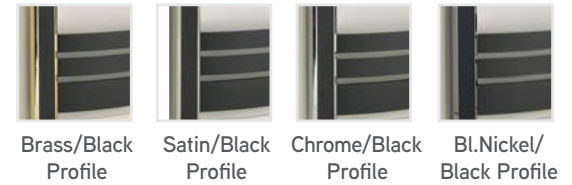

Ellipsis



The Ellipsis 'Hole in the wall' with Chrome/Black trim. Open fronted in pebble (inset)



This beautifully styled hole in the wall appliance produces a powerful output.

*Its warmth will transform your living environment. The Ellipsis is suitable for Class 1 and Class 2 flue types and is available in Coal or Pebble**.*

The Ellipsis is available in open fronted or glass fronted HE format. The Ellipsis open fronted has a pebble option. This product is only available as manual control.

The Wildfire Ellipsis combines style, efficiency and space saving to provide the ultimate solution for an open fronted gas or glass fronted fire. If you are looking for realism coupled with powerful heat whilst retaining efficiency then this is the product for you.

DIMENSIONS

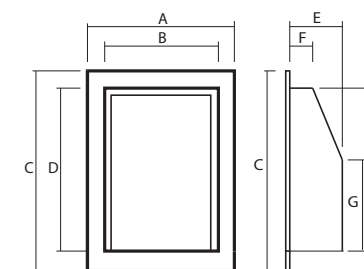

OPEN FRONTED

- A) 512mm
- B) 403mm
- C) 660mm (HIW)
- C) 607mm (3 Sided)
- D) 553mm
- E) 173mm
- F) 104mm
- G) 358mm

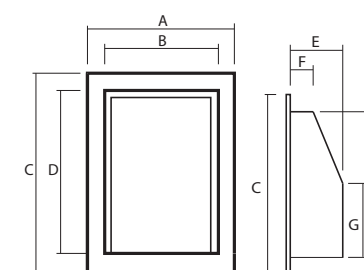

GLASS FRONTED

- A) 512mm
- B) 403mm
- C) 660mm (HIW)
- C) 607mm (3 Sided)
- D) 553mm
- E) 198mm
- F) 174mm
- G) 358mm

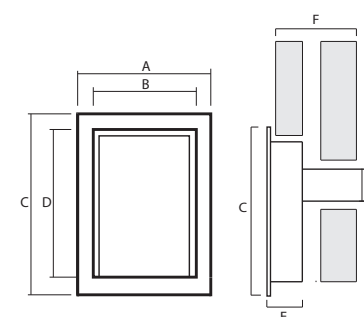

BALANCED FLUE

- A) 512mm
- B) 406mm
- C) 660mm (HIW)
- C) 607mm (3 Sided)
- D) 552mm
- E) 186mm
- F) 290-624mm
- G) 152mm

FLUE OPTIONS

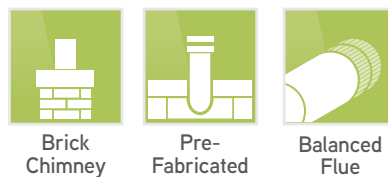

CONTROL



FUEL BEDS

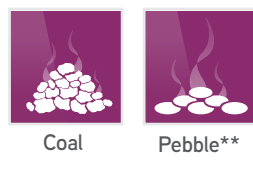

*Glass fronted only **Open fronted only

FUEL



ELLIPSIS TRIM OPTIONS



Also available in 3 sided for hearth mounted version

GAS CONSUMPTION

For inputs and outputs and efficiency classes refer to the relevant pages as below:

- OPEN FRONTED** (REFER TO MONTESE - PAGE 46)
- GLASS FRONTED** (REFER TO CRESSIDA - PAGE 34)
- BALANCED FLUE** (REFER TO THERMES - PAGE 40)



Ravel Gas Stove

NEW
2021

The Ravel Stove is a stunning addition to any open fireplace. Based on the proven under-log burner system of the highly successful Ravel gas fire.

*This gas stove version features crisp and clean lines only possible with the light weight aluminium extrusion employed in this design. Suitable for use with Class 1, Class 2 and precast flues.**

The unique burner system allows the fire to be turned to low whilst still retaining an impressive flame effect.



HE

Ravel Gas Stove shown inset with black handle and control lever. Available as an optional extra.

82%
EFFICIENCY

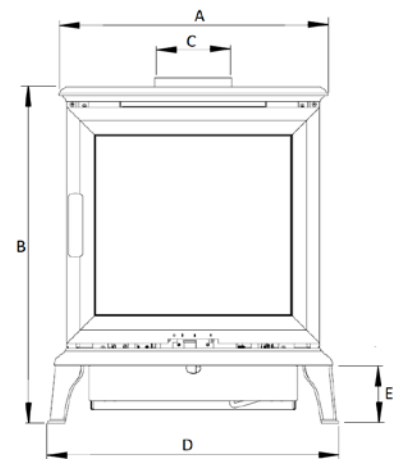

DIMENSIONS

- A) 464mm
- B) 584mm
- C) 127mm
- D) 502mm
- E) 100mm

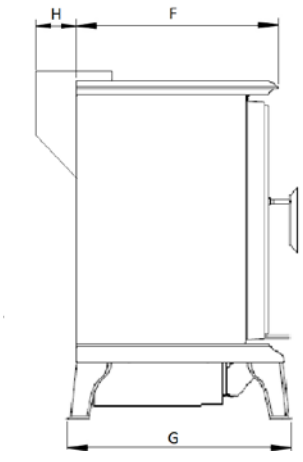

- F) 289mm
- G) 315mm
- H) 67mm

*Precast flue kit is additional part.

FLUE OPTIONS

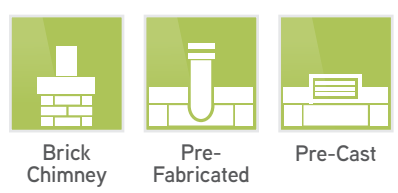

CONTROL



FUEL BED



FUEL



WATCH VIDEO



Our 5 year limited guarantee is managed directly by Wildfire through our extensive network of service centres throughout the UK. Choose Wildfire for style, performance, reliability, value and peace of mind.*

GAS CONSUMPTION

Heat Input (High)	4.25kW	Heat Output (High)	3.1kW
Heat Input (Low)	2.6kW	Heat Output (Low)	1.8kW

ENERGY EFFICIENCY CLASS D

Trim Options

Choose the trim and fret options from the selection on this page. The Standard and Creative trim and fret options will fit **MOST** of the products in this brochure. The Ellipsis trim will fit manual control fires only. For further fret options consult your retailer.

SLIDE LEVER OPTIONS



Brass



Chrome



Black Nickel



Black

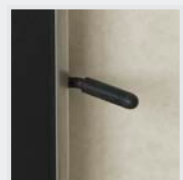

Ezi-Grip

STANDARD TRIM OPTIONS

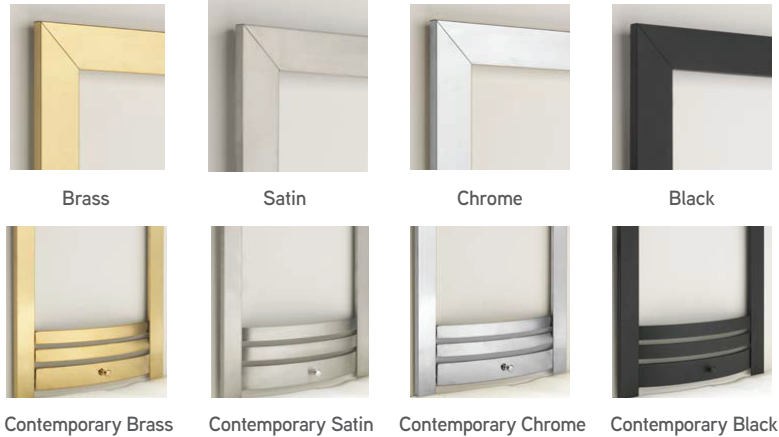

CREATIVE TRIM OPTIONS

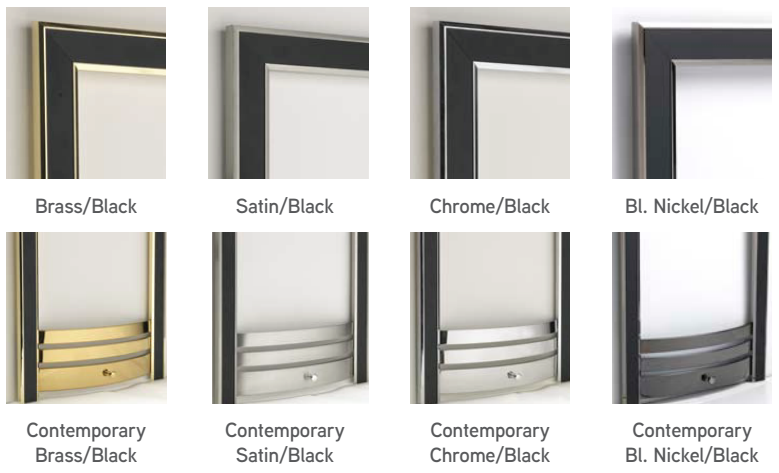

PROFILE TRIM OPTIONS

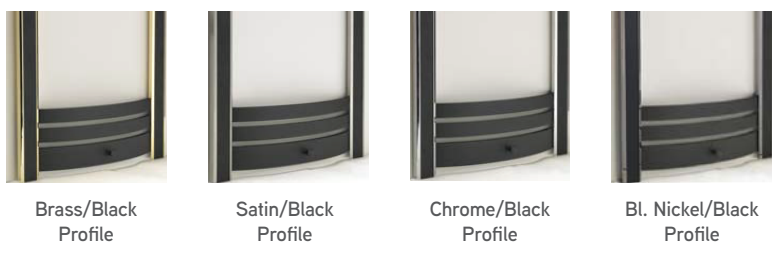

ELLIPSIS TRIM OPTIONS



Ellipsis trim only suitable for manual control appliances

PANAMA TRIM OPTIONS

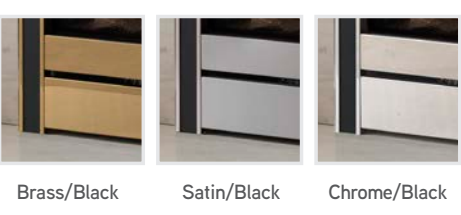

RAVEL TRIM OPTIONS

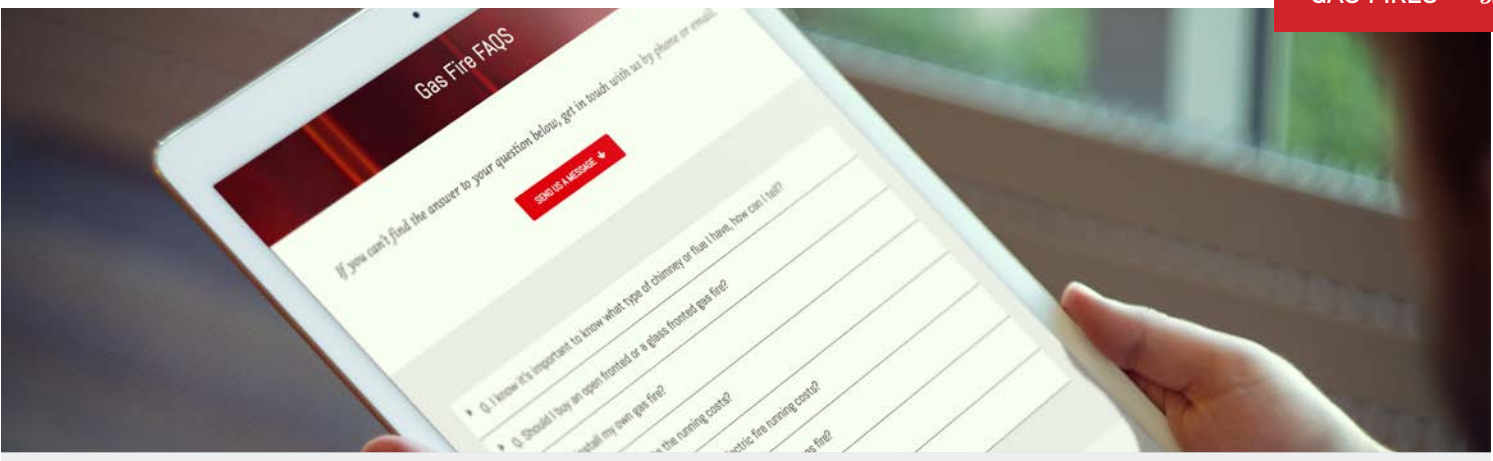
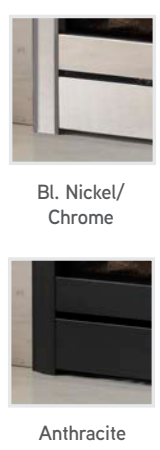

Technical Information

Use the chart below to quickly check the options available for each product contained in this brochure. You will also find the flue types which products can be installed into. For further information consult the manufacturer's installation instructions or ask your local retailer for further advice.

PAGE NO.	FIRES	COAL OPTION	PEBBLE OPTION	LOG OPTION	MANUAL CONTROL	SLIDE CONTROL	PRE-CAST FLUE	CLASS II FLUE	CLASS I FLUE	BALANCED FLUE	XE INCLUDED	XE OPTIONAL	HE
8-9	HE900 (STD & PCF)			✓		✓	✓	✓	✓				✓
10-11	HE900 (STD & PCF)			✓		✓	✓	✓	✓				✓
12-13	HE950L (STD & PCF)			✓		✓	✓	✓	✓				✓
14-15	HE950L (STD & PCF)			✓		✓	✓	✓	✓				✓
16-21	RAVEL 600			✓		✓		✓	✓				✓
22-27	RAVEL 800			✓		✓		✓	✓				✓
28-31	RAVEL 750			✓		✓		✓	✓				✓
32-33	PANAMA			✓		✓		✓	✓				✓
34-35	CRESSIDA HE	✓			✓	✓		✓	✓				✓
36-37	PESARO HE	✓				✓	✓	✓	✓				✓
38-39	RAVEL HE			✓		✓		✓	✓				✓
40-41	THERMES	✓			✓	✓				✓			✓
42-43	BF960SL			✓		✓				✓			✓
44-45	CAVELLO XE	✓	✓		✓	✓		✓	✓		✓		
46-47	MONTESE	✓	✓		✓	✓	✓	✓	✓			✓	
48-49	CERALIS	✓	✓		✓	✓	✓	✓	✓			✓	
50-51	ELLIPSIS HIW	✓	✓*		✓			✓	✓			✓	✓**
52-53	RAVEL GAS STOVE			✓		✓	✓	✓	✓				✓

*open fronted only **glass fronted only

Some things you need to know

Electric Fireplace Suites

All of our electric appliances provide up to 2kW of instantaneous heat. At the push of a button, or from a programmed timer, this clean convected heat will power warmth into your room whenever you need it.

A mesmerising flame effect completes these beautiful products. With stunning log arrangements and a choice of three levels of flame control and up to five brightness/intensity levels. The vibrant flame effects provide that feeling of comfort even when the heat is not switched on. The flame effect system is a safe convenient and efficient design which uses only LED technology to ensure that running costs in flame only mode are extremely low.

The Wildfire range of suites couple this electric fire technology with exquisite micro marble fireplaces. Available in a range of colours (see pages 70 & 71) these suites all allow a flat to wall installation*

*The Panama E22 and Ravel E16 installed in the Salvador suite require a spacer frame (supplied separately) to allow flat to wall installation. If no spacer is required for this suite then a 65mm recess for the width and height of the appliance is required.



We guarantee our electric fire products for a period of 1 year from installation and our customer service staff are always on hand to help you with any query you may have with your product.*

Our 1 year guarantee is managed directly by Wildfire through our extensive network of service centres throughout the UK. Choose Wildfire for style, performance, reliability, value and peace of mind.*



The distinguishing feature of a flame effect electric fire is the ability to provide a 'feel warm' comfort level with its' mesmerising glow at any time of the year. An energy efficient way to produce a stunning effect with minimal running costs. The instantaneous heat can be called upon on those colder evenings when its just not practical or cost efficient to turn on the central heating.



What control options are available?

The multifunction remote control handset provides ultimate controllability for your electric appliance. From 'Normal' operating mode where the appliance will run continually until the required temperature is set, to daily or weekly timer settings to give you complete control over the heating function.

A countdown timer is also included so the unit can be automatically be powered down after a predetermined length of time.

This beautifully styled remote features an internal thermostat to ensure it senses the right temperature in the room. An LCD display features all of the control functions available including flame setting and flame intensity.



HE 900E (Avellino Suite)



The HE900E Avellino is a 52” flat to wall marble electric fireplace suite.

This fully electronic remote control fireplace offers 7 day thermostatic operation. The suite is available in all white or white with a distinctive grey highlight. A variety of flame effects provide a great solution to suit the mood for the day.

DIMENSIONS

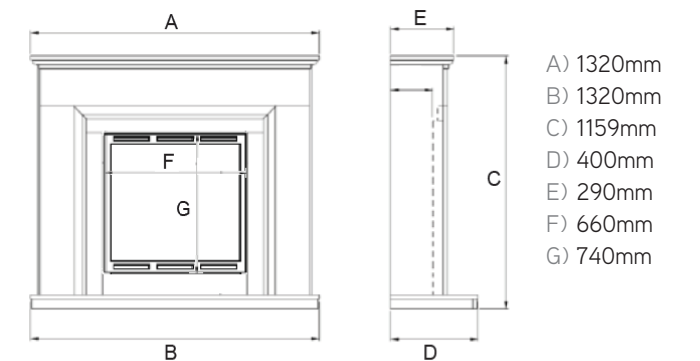

For full technical and dimensional specifications refer to pages 70 and 71.

CONTROL



Remote

FUEL BED



Log

FUEL



Electric

STANDARD MANTEL FINISH OPTIONS

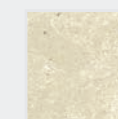

Manila

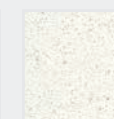

White

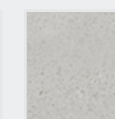

Grey

Available with grey inner border - see similar detail on the Seville Suite - page 12.

HE 950LE (Seville Suite)



The HE950LE Seville is a 52" flat to wall marble electric fireplace suite.

This incredible fireplace has been launched to complement the already successful, multi award winning HE950L Seville gas suite. It is available in the same flawless micro marble colour options, white or white with grey slip highlights. The appliance is fully thermostatic and has timers to allow heating to take place at the appropriate times.

DIMENSIONS

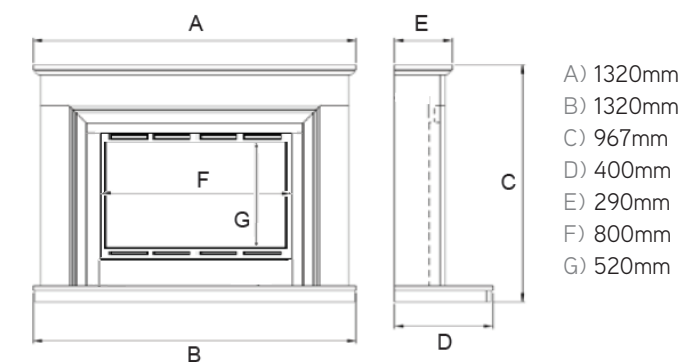

For full technical and dimensional specifications refer to pages 70 and 71.

CONTROL



Remote

FUEL BED



Log

FUEL



Electric

STANDARD MANTEL FINISH OPTIONS

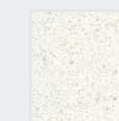

White

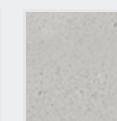

Grey

Available with grey inner border - see similar detail on the Seville Suite - page 12.

HE 950LE (Palma Suite)



The HE950LE Palma is a 52" flat to wall marble electric fireplace suite.

This Palma electric fireplace suite is available in manila or white micro marble. With all the charm and beauty of natural marble this suite offers clean lines to encapsulate the Eco Design compliant HE950LE electric fire.

A seven day timer with digital thermostatic control provides full controllability of this stunning focal point. A 2kW heat output will supply the heat you need at the touch of a button. Now relax and enjoy this masterpiece.

DIMENSIONS

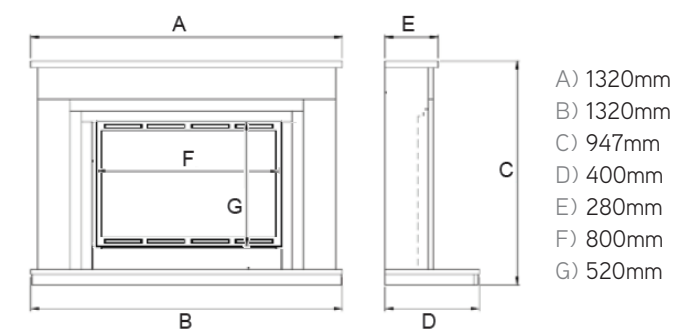

For full technical and dimensional specifications refer to pages 70 and 71.

CONTROL



Remote

FUEL BED



Log

FUEL



Electric

STANDARD MANTEL FINISH OPTIONS

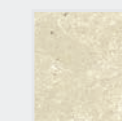

Manila

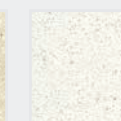

White

Panama E22 (Avellino Suite)



The Panama E22 Avellino is a 52" flat to wall marble electric fireplace suite, available in all white or white with grey slip highlights.

The Panama E22 can be supplied with numerous trim options, from the black anthracite or the two tone anodised range featuring brass, satin, chrome, black nickel & the new black nickel/chrome effect. The appliance is a fully electronic remote control fireplace offering a 7 day thermostatic operation. A variety of flame effects can be selected using the digital remote control, along with a whole range of other programmable features. For full information on the remote system refer to pages 70 and 71.

DIMENSIONS

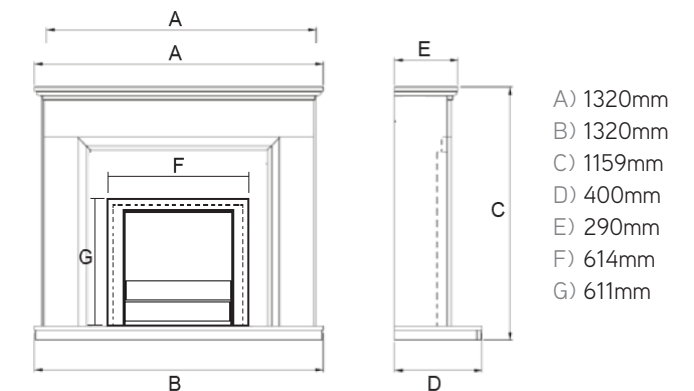

PANAMA TRIM OPTIONS

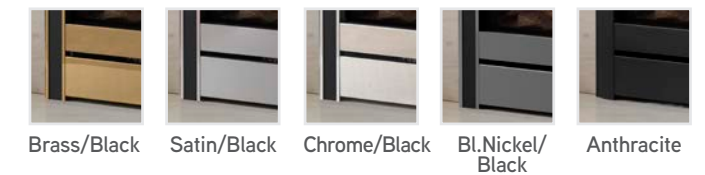

CONTROL



Remote

FUEL BED



Log

FUEL



Electric

STANDARD MANTEL FINISH OPTIONS

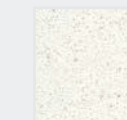

White

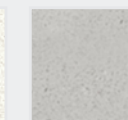

Grey

Available with grey inner border - see similar detail on the Seville Suite - page 12.

Panama E22 (Salvador Suite)



The Panama E22 Salvador is a 54” micro marble electric fire suite, available in all white or manila.

The Panama E22 can be supplied with numerous trim options, from the black anthracite or the two tone anodised range featuring brass, satin, chrome, black nickel & the new black nickel/chrome effect. The appliance is a fully electronic remote control fireplace offering a 7 day thermostatic operation. A variety of flame effects can be selected using the digital remote control, along with a whole range of other programmable features. For full information on the remote system refer to pages 70 and 71.

This product can be installed onto a flat wall if a spacer (available separately) is fitted. Alternatively a recess behind the fireplace can be made to accept the appliance rear section, talk to your retailer for further details.

DIMENSIONS

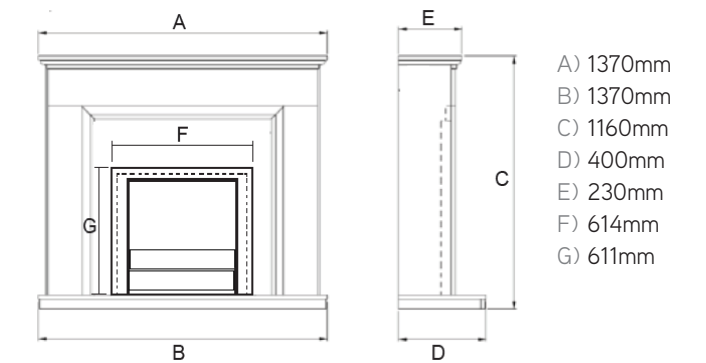

PANAMA TRIM OPTIONS



CONTROL

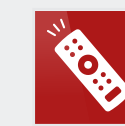

Remote

FUEL BED



Log

FUEL



Electric

STANDARD MANTEL FINISH OPTIONS

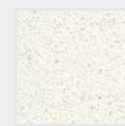

White

Ravel E16 (Salvador Suite)



The Ravel E16 Salvador is a 54" micro marble electric fireplace suite, available in all white or manila.

The Ravel E16 can be supplied with either a black anthracite or a black nickel and chrome trim option. The fireplace can be installed onto a flat wall if a spacer (available separately) is fitted. Alternatively a recess behind the fireplace can be made to accept the appliance rear section, talk to your retailer for further details. The appliance is a fully electronic remote control fireplace offering a 7 day thermostatic operation. A variety of flame effects can be selected using the digital remote control, along with a whole range of other programmable features.

For full information on the remote system refer to pages 70 and 71.

DIMENSIONS

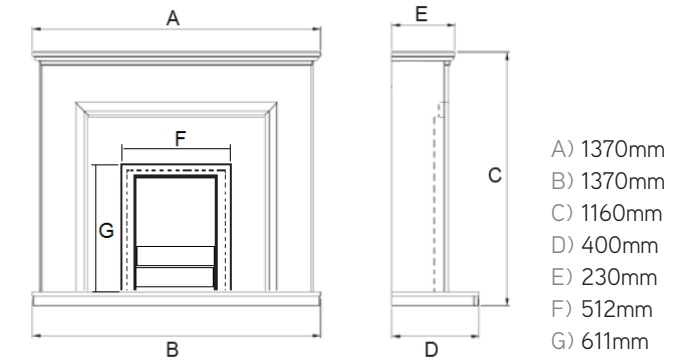

RAVEL TRIM OPTIONS



Bl.Nickel/Chrome

Anthracite

CONTROL



Remote

FUEL BED



Log

FUEL



Electric

STANDARD MANTEL FINISH OPTIONS

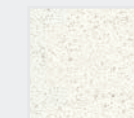

White

Ravel shown with Contemporary Bl.Nickel/Chrome trim.

Featured with a Wildfire Salvador 54" surround in Manilla Micro Marble

Marble and Trim options electrical

	AVELLINO HE900E	SEVILLE HE950LE	PALMA HE950LE	AVELLINO PANAMA E22	SALVADOR PANAMA E22	SALVADOR E16
MARBLE COLOURS	W / WG / M	W / WG	W / M	W / WG	W / M	W / M
TRIM OPTION	As pictured	As pictured	As pictured	Br / Sa / Ch / An / BN	Br / Sa / Ch / An / BN	Br / Sa / Ch / An / BN
REMOTE CONTROL	Yes	Yes	Yes	Yes	Yes	Yes
THERMOSTATIC	Yes	Yes	Yes	Yes	Yes	Yes
PROGRAMMABLE TIMER	Yes	Yes	Yes	Yes	Yes	Yes
FLAME COLOUR SETTINGS	3	3	3	3	3	3
FLAME INTENSITY SETTINGS	5	5	5	5	5	5
MAX HEATER OUTPUT	2kW	2kW	2kW	2kW	2kW	2kW
SPACER OPTION FOR FLAT-WALL FIX	N/A	N/A	N/A	N/A	Yes	Yes

KEY Marble Colours: W: White WG: White with Grey Slips M: Manila
 Trim Options: Br: Brass/Black Sa: Satin/Black Ch: Chrome Black An: Anthracite BN: Black Nickel/Black

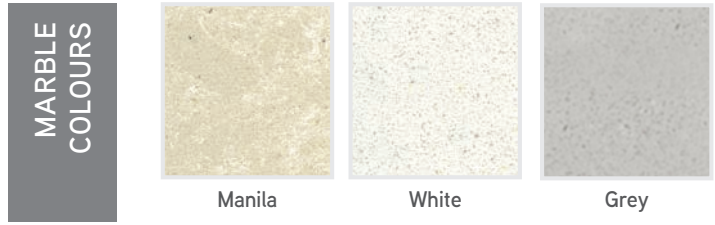

Fireplace Dimensions

PAGE NO.	ELECTRIC FIREPLACE SUITE	HEARTH WIDTH	HEARTH DEPTH	SHELF WIDTH	SHELF DEPTH	OVERALL HEIGHT
58-59	AVELLINO HE900E	1320mm	400mm	1320mm	290mm	1159mm
60-61	SEVILLE HE950LE	1320mm	400mm	1320mm	290mm	967mm
62-63	PALMA HE950LE	1320mm	400mm	1320mm	280mm	947mm
64-65	AVELLINO PANAMA E22	1320mm	400mm	1320mm	290mm	1159mm
66-67	SALVADOR PANAMA E22	1370mm	400mm	1370mm	230mm	1160mm
68-69	SALVADOR RAVEL E16	1370mm	400mm	1370mm	230mm	1160mm





HEARTH PRODUCTS

Sales Enquiries: sales@hearthproducts.co.uk

Technical Enquiries: customerservice@hearthproducts.co.uk

Tel: 01785 225401 | **Fax:** 01785 225501

Hearth Products Ltd, Unit 14 Brindley Close,
Tollgate Industrial Estate, Stafford ST16 3SU



www.wildfiregas.co.uk
www.wildfireelectric.co.uk

Scan the QR code with your mobile device
to be directed to the Wildfire website.

UK CA NI

