



GAZCO

Gas and Electric Stoves

A Warm Welcome

Nothing creates an inviting atmosphere quite like a Gazco stove. The centrepiece of any home, it will add warmth and character to any room or living space – even if you don't have a chimney! Whether you want to achieve a minimalist, contemporary look, or have your heart set on a more traditional stove, this brochure will help you make the perfect choice, whatever your interior tastes.

From the highly efficient contemporary Gas Loft range with all its style and elegance, to the stunning cast iron detail on our traditional Sheraton stove, these innovative designs will appeal to any modern or traditional home.

There is also a range of highly realistic, electric log-effect stoves featuring Gazco's Chromalight® technology. These electric versions open up new possibilities such as conservatories, kitchens, dining rooms and bedrooms for you to have the warmth and character of a Gazco stove in your home.





Contents

The Gazco Pedigree..... 04

Expert Retailer Network 05

Traditional Stoves..... 06 - 07

Sheraton 5.....08 - 11

Marlborough2.....12 - 15

Stockton 16 - 21

Huntingdon22 - 29

Contemporary Styles30 - 31

Loft32 - 39

Vogue Midi & Midi T 40 - 49

Vision 50 - 57

Studio Freestanding Gas58 - 61

Stove Benches 62 - 63

Home & Flue Requirements 64 - 65

Remote Controls..... 66

Additional Information..... 67

Technical Information 68 - 77

Balanced Flue Systems..... 78

Wood & Multi-fuel Stoves 79

Cover Images

Left: Sheraton 5 Gas with Grafton Limestone mantel and Belgravia polished cast front.

Right: Loft Gas with Steel Log Store and Top Section.



Stockton 5 Electric with Log & Pebble fuel effect and Amber flame setting.
Shown with Claremont Limestone mantel

The Gazco Pedigree...

Our gas and electric stoves are innovatively designed, solidly built and meticulously tested to ensure they continue to heat your home for many years to come.

Innovation in Design

With creativity and innovation at the heart of what we do, our expert design team continues to create unique, industry leading stoves that both inspire and endure. From the moment the first concept is sketched, through to the mapping of airflow using cutting-edge software, stove design is a science we have been perfecting since 1988.

We continually invest in our research and development facilities to ensure our team is at the forefront of fire design. Our pioneering concepts and technologies make our gas and electric models some of the most sought after stoves available.

Quality Construction

Built with the finest quality materials, each stove is engineered here in the UK. Cast iron and heavy gauge steel are used across our ranges to ensure each stove is built to the highest tolerances. Cast iron allows for the casting of intricate designs, making it perfect for traditional stoves. Heavy gauge steel is also an outstanding choice for stove construction, offering greater scope for design thanks to its versatile nature.

Rigorously Tested

In our pioneering laboratories, each stove is put through a series of demanding tests to make sure it performs not only reliably but exceptionally. Here our development engineers continually refine our products to exceed the toughest UK and European standards, ensuring they are some of the cleanest burning and safest stoves available.

The Stovax Heating Group itself is also subject to stringent tests and we are proud to be an ISO9001 and ISO 14001 accredited company, recognised for our continued commitment to technical innovation, high quality products and excellent customer and after-sales care.



Expert Retailer Network

We take great care to ensure that our stoves are designed, tested and manufactured to the highest possible quality and safety standards. We are just as concerned to make certain that they are sold and installed correctly so that you enjoy years of pleasure from your purchase.

Accordingly, you will find our products are only available from experienced, independent retailers who will be happy to show you a selection of models locally in their showrooms, often fully operational. These independent retailers will discuss your individual requirements both technical (such as sizing the heat output to your room and advising on your flue type) and design, and ensure that you select the most appropriate product for your home. These retailers will also be able to advise on, or assist with, the installation process as well as help provide any after-sales support and servicing your appliance may require in the future.

Whilst we encourage our retailers to promote fireplace products and their outlets via the internet, we do not believe suitable levels of customer care and satisfaction can be obtained from purchasing the product only online and we would strongly recommend that you consider this when undertaking your research and making a purchasing decision. Furthermore, please be aware that we do not offer technical support (beyond our statutory responsibilities) to products bought via nationwide online sales, where this support would normally be offered by one of our qualified, independent retailers.

Furthermore, Gazco fires and stoves purchased from within our Expert Retailer Network will have the additional benefit of a greatly extended warranty period, subject to terms and conditions. Full details can be found at www.gazco.com.

You can find and support your nearest retailer by visiting: www.gazco.com/find-a-retailer



Warranty

Your Gazco Expert Retailer will provide you with a Two Year Warranty for your new gas or electric stove. The warranty for gas stoves can be extended to a period of five years by registering your stove with Gazco. Please note, these warranties exclude certain consumable parts. Stoves purchased outside of Gazco's Expert Retailer Network will carry a standard One Year non-extendable Warranty. Full warranty terms and conditions are available to view at www.gazco.com.



WIN the cost of your product back!

by registering your product online for your free extended warranty. See page 67 for details.





Traditional Stoves

Our traditional stoves combine classic casting details with modern combustion technology. Timelessly styled, they add elegance and character to period and contemporary interiors alike.

Sheraton 5	08 - 11
Marlborough2	12 - 15
Stockton	16 - 21
Huntingdon	22 - 29

Sheraton 5 Gas

Beautifully made, this timeless stove features cast iron bevelling and corncoring to the door, top plate and base, for aesthetics you can appreciate even when it's off!



Sheraton 5 Gas

	Heat Output & Efficiency			Chimney or Flue Options			Fuel Bed	Lining	Control
	kW HEAT OUTPUT RANGE	E% EFFICIENCY	E EFFICIENCY CLASS	BRICK CHIMNEY	PRE-FABRICATED	BALANCED FLUE	LOGS	ECHOFLAME BLACK GLASS	FULLY-SEQUENTIAL THERMOSTATIC REMOTE
Conventional Flue	1.60 - 4.00kW	76%	D	✓	✓	✗	✓	✓	✓ Page 66
Balanced Flue	1.80 - 4.00kW	90.6%	B	✗	✗	✓	✓	✓	✓ Page 66

Optional Linerless Flue Kit

This option eliminates the need for the chimney to be fully lined and any associated labour, facilitating a simpler and more cost effective solution. For more information see page 64.

See page 10 for electric model

See front cover for additional image

Efficiency figures given are based upon the maximum heat output achieved for these models. For additional information, specifications and complete model choices, please see pages 64 onwards.



SEE IT BURNING AT:
gazco.com/sheratongas



SEE IT BURNING AT:

[gazco.com/sheratonelectric](https://www.gazco.com/sheratonelectric)



*Sheraton 5 Electric with Log & Pebble fuel effect
and Amber flame setting*

Sheraton 5 Electric

With its mesmerising display, the Sheraton 5 electric lets you mix and match fuel effects to create a bespoke focal point to rival the allure of a real woodburner.



Sheraton 5 Electric with Log & Pebble fuel effect and Amber flame setting with Grafton Limestone mantel

	Heat Output	Interchangeable Fuel Beds		Lighting Effects			Control
	kW HEAT OUTPUT RANGE	LOG AND PEBBLE	CRYSTAL ICE EFFECT	CHROMALIGHT IMMERSIVE LED SYSTEM	MULTIPLE FLAME EFFECTS	13 FUEL BED LIGHTING COLOURS	PROGRAMMABLE THERMOSTATIC ECO REMOTE
Sheraton 5 Electric	0.75 - 1.50kW or flame effect only	✓	✓	✓	✓	✓	✓ Page 66

See page 8 for gas models

For additional information, specifications and complete model choices, please see pages 64 onwards.



SEE IT BURNING AT:

gazco.com/marlborough2gas

















Marlborough2 Gas

Country or city, traditional or contemporary, the innovative Gas Marlborough2 has the flexibility to suit your lifestyle and your décor. With their expansive viewing windows, enjoy the dancing flames and warm ambience from the comfort of your sofa.



Small Gas Marlborough2 conventional flue

		Heat Output & Efficiency			Chimney or Flue Options			Fuel Bed	Lining	Control Options (Page 66)		
												
	HEAT OUTPUT RANGE	EFFICIENCY	EFFICIENCY CLASS	BRICK CHIMNEY	PRE-FABRICATED	BALANCED FLUE	LOGS	VERMICULITE	MANUAL	STANDARD UPGRADEABLE REMOTE	PROG. THERMOSTATIC UPGRADEABLE REMOTE	
Small - Conventional Flue		1.20 - 2.30kW	76%	E	✓	✓	✗	✓	✓	✓	✓	✓
Small - Balanced Flue		1.20 - 2.50kW	85.1%	C*	✗	✗	✓	✓	✓	✓	✓	✓
Medium - Conventional Flue		1.80 - 4.80kW	78%	E	✓	✓	✗	✓	✓	✓	✓	✓
Medium - Balanced Flue		2.70 - 5.50kW	90.8%	B*	✗	✗	✓	✓	✓	✓	✓	✓



See page 14 for electric models

Efficiency figures given are based upon the maximum heat output achieved for these models. For additional information, specifications and complete model choices, please see pages 64 onwards. * When using Programmable Thermostatic Remote

Marlborough2 Electric

Featuring the same distinctive styling as the gas versions, the Marlborough2 electric offers an amazingly realistic flame effect with or without heat – all at the touch of a button.



TRADITIONAL STOVES

	Heat Output	Interchangeable Fuel Beds		Lighting Effects			Control
	kW HEAT OUTPUT RANGE	 LOG AND PEBBLE	 CRYSTAL ICE EFFECT	 CHROMALIGHT IMMERSIVE LED SYSTEM	 MULTIPLE FLAME EFFECTS	 13 FUEL BED LIGHTING COLOURS	 PROGRAMMABLE THERMOSTATIC ECO REMOTE
Marlborough2 Electric Small & Medium	1.00 - 2.00kW or flame effect only	✓	✓	✓	✓	✓	✓ Page 66

See page 12 for gas models

For additional information, specifications and complete model choices, please see pages 64 onwards.

SEE IT BURNING AT:
[gazco.com/marlborough2electric](https://www.gazco.com/marlborough2electric)





SEE IT BURNING AT:
gazco.com/stockton2gas



Stockton2 Gas















Using cast iron for the door and heavy gauge steel for the body, Gas Stockton2 stoves combine simple, understated lines with Gazco's superb living flame technology. See page 18 for Stockton 5 model.



Medium Gas Stockton2 conventional flue



Small Gas Stockton2 balanced flue

		Heat Output & Efficiency			Chimney or Flue Options			Fuel Bed	Lining	Control Options (Page 66)		
												
	HEAT OUTPUT RANGE	EFFICIENCY	EFFICIENCY CLASS	BRICK CHIMNEY	PRE-FABRICATED	BALANCED FLUE	LOGS	VERMICULITE	MANUAL	STANDARD UPGRADEABLE REMOTE	PROG. THERMOSTATIC UPGRADEABLE REMOTE	
Small - Conventional Flue	 1.20 - 2.30kW	76%	E	✓	✓	✗	✓	✓	✓	✓	✓	
Small - Balanced Flue	 1.20 - 2.50kW	85.1%	C*	✗	✗	✓	✓	✓	✓	✓	✓	
Medium - Conventional Flue	 1.80 - 4.80kW	78%	E	✓	✓	✗	✓	✓	✓	✓	✓	
Medium - Balanced Flue	 2.70 - 5.50kW	90.8%	B*	✗	✗	✓	✓	✓	✓	✓	✓	



See page 20 for electric models

Efficiency figures given are based upon the maximum heat output achieved for these models. For additional information, specifications and complete model choices, please see pages 64 onwards.

* When using Programmable Thermostatic Remote



Stockton 5 Gas

With authentic woodburning stove styling, right down to the hinged door with handle, the Gas Stockton 5 is conveniently sized between the small and medium models featured on the previous page.



	Heat Output & Efficiency			Chimney or Flue Options			Fuel Bed		Lining	Control Options (Page 66)		
	HEAT OUTPUT RANGE	EFFICIENCY	EFFICIENCY CLASS	BRICK CHIMNEY	PRE-FABRICATED	BALANCED FLUE	LOGS	COALS	POLISHED STAINLESS STEEL	MANUAL	STANDARD UPGRADEABLE REMOTE	PROG. THERMOSTATIC UPGRADEABLE REMOTE
Conventional Flue	1.40 - 3.00kW	73%	E	✓	✓	✗	✗	✓	✓	✓	✓	✓
Balanced Flue	2.20 - 3.50kW	91.8%	B*	✗	✗	✓	✓	✗	✓	✓	✓	✓



See page 20 for electric models

Efficiency figures given are based upon the maximum heat output achieved for these models. For additional information, specifications and complete model choices, please see pages 64 onwards.

† Please note this is a viable installation in stone, but not suitable for combustible materials.

* When using Programmable Thermostatic Remote

See page 69 for additional image

Stockton Electric

The Stockton Electric range suits both the modern and traditional home, with classic good looks and a striking three-dimensional flame effect for increased realism.



Stockton2 Medium Electric with Log & Pebble fuel effect and Amber flame setting



Stockton2 Small Electric with Log & Pebble fuel effect and Amber flame setting

	Heat Output	Interchangeable Fuel Beds		Lighting Effects			Control
	kW HEAT OUTPUT RANGE	LOG AND PEBBLE	CRYSTAL ICE EFFECT	CHROMALIGHT IMMERSIVE LED SYSTEM	MULTIPLE FLAME EFFECTS	13 FUEL BED LIGHTING COLOURS	PROGRAMMABLE THERMOSTATIC ECO REMOTE
Stockton Electric (Small, 5 and Medium)	0.75 - 1.50kW or flame effect only	✓	✓	✓	✓	✓	✓ Page 66

See pages 16-19 for gas models

See page 4 for additional image

For additional information, specifications and complete model choices, please see pages 64 onwards.

SEE IT BURNING AT:
[gazco.com/stocktonelectric](https://www.gazco.com/stocktonelectric)



Stockton 5 Electric with Log & Pebble
fuel effect and Amber flame setting



SEE IT BURNING AT:
gazco.com/huntingdon20gas



Huntingdon 20 Gas

Presented in three finishes, the compact Gas Huntingdon 20's proportions make it perfect for British fireplace openings, whilst the choice of a clear or tracery door further expands the styling options.



Gas Huntingdon 20 with Clear Door in Ivory Enamel



Gas Huntingdon 20 with Tracery Door in Matt Black

	Heat Output & Efficiency			Chimney or Flue Options			Fuel Bed	Lining	Styling Options		Control Options (Page 66)		
	kW HEAT OUTPUT RANGE	E% EFFICIENCY	E EFFICIENCY CLASS	BRICK CHIMNEY	PRE-FABRICATED	BALANCED FLUE	LOGS	VERMICULITE	CLEAR & TRACERY DOOR	MATT BLACK, IVORY ENAMEL & MATT IVORY FINISHES	MANUAL	STANDARD UPGRADEABLE REMOTE	PROG. THERMOSTATIC UPGRADEABLE REMOTE
Conventional Flue	1.20 - 2.30kW	76%	E	✓	✓	✗	✓	✓	✓	✓	✓	✓	✓
Balanced Flue	1.20 - 2.50kW	85.1%	C*	✗	✗	✓	✓	✓	✓	✓	✓	✓	✓

Efficiency figures given are based upon the maximum heat output achieved for these models. For additional information, specifications and complete model choices, please see pages 64 onwards.

* When using Programmable Thermostatic Remote



See page 28 for electric models



SEE IT BURNING AT:
[gazco.com/huntingdon30gas](https://www.gazco.com/huntingdon30gas)

Gas Huntingdon 30 with Tracery Door in Matt Black



Huntingdon 30 Gas

The Gas Huntingdon 30 offers elegant Gothic styling, and with its beautiful flame picture, provides ample warmth and style to any interior.



	Heat Output & Efficiency			Chimney or Flue Options			Fuel Bed	Lining	Styling Options		Control Options (Page 66)		
	kW HEAT OUTPUT RANGE	E% EFFICIENCY	E EFFICIENCY CLASS	BRICK CHIMNEY	PRE-FABRICATED	BALANCED FLUE	LOGS	VERMICULITE	CLEAR & TRACERY DOOR	MATT BLACK, IVORY ENAMEL & MATT IVORY FINISHES	MANUAL	STANDARD UPGRADEABLE REMOTE	PROG. THERMOSTATIC UPGRADEABLE REMOTE
Conventional Flue	1.50 - 3.10kW	75%	E	✓	✓	✗	✓	✓	✓	✓	✓	✓	✓
Balanced Flue	2.10 - 3.80kW	95.4%	A*	✗	✗	✓	✓	✓	✓	✓	✓	✓	✓

Efficiency figures given are based upon the maximum heat output achieved for these models. For additional information, specifications and complete model choices, please see pages 64 onwards.

* When using Programmable Thermostatic Remote

See page 28 for electric models

See rear cover for additional image



SEE IT BURNING AT:
[gazco.com/huntingdon40gas](https://www.gazco.com/huntingdon40gas)



Huntingdon 40 Gas

The largest model in the Huntingdon range, the Gas Huntingdon 40 is perfectly at home in big open fireplaces or spacious interiors.



Gas Huntingdon 40 with Tracery Door in Matt Black



Gas Huntingdon 40 with Tracery Door in Matt Ivory.
Shown with Sandringham Limestone Mantel

TRADITIONAL STOVES

	Heat Output & Efficiency			Chimney or Flue Options			Fuel Bed	Lining	Styling Options		Control Options (Page 66)		
	kW HEAT OUTPUT RANGE	E% EFFICIENCY	E EFFICIENCY CLASS	BRICK CHIMNEY	PRE-FABRICATED	BALANCED FLUE	LOGS	VERMICULITE	CLEAR & TRACERY DOOR	MATT BLACK, IVORY ENAMEL & MATT IVORY FINISHES	MANUAL	STANDARD UPGRADEABLE REMOTE	PROG. THERMOSTATIC UPGRADEABLE REMOTE
Conventional Flue	1.80 - 4.80kW	78%	E	✓	✓	✗	✓	✓	✓	✓	✓	✓	✓
Balanced Flue	2.70 - 5.50kW	90.8%	B*	✗	✗	✓	✓	✓	✓	✓	✓	✓	✓

Efficiency figures given are based upon the maximum heat output achieved for these models. For additional information, specifications and complete model choices, please see pages 64 onwards.

* When using Programmable Thermostatic Remote

See page 28 for electric models

See page 6 for additional image

Huntingdon Electric

Available in three finishes, the fine castings of the Huntingdon Electric range are brought to life with Gazco's Chromalight® Immersive LED System, offering all the fireside ambience of real flames.



Huntingdon 30 Electric with Tracery Door in Matt Ivory with Log & Pebble fuel effect and Amber flame setting



Huntingdon 20 Electric with Tracery Door in Matt Black with Log & Pebble fuel effect and Amber flame setting

	Heat Output	Interchangeable Fuel Beds		Lighting Effects			Styling Options		Control
	kW HEAT OUTPUT RANGE	LOG AND PEBBLE	CRYSTAL ICE EFFECT	CHROMALIGHT IMMERSIVE LED SYSTEM	MULTIPLE FLAME EFFECTS	13 FUEL BED LIGHTING COLOURS	CLEAR & TRACERY DOOR	MATT BLACK, IVORY ENAMEL & MATT IVORY FINISHES	PROGRAMMABLE THERMOSTATIC ECO REMOTE
Huntingdon Electric (20, 30 & 40)	1.00 - 2.00kW or flame effect only	✓	✓	✓	✓	✓	✓	✓	✓ Page 66

For additional information, specifications and complete model choices, please see pages 64 onwards.

See pages 22 - 27 for gas models

SEE IT BURNING AT:
[gazco.com/huntingdonelectric](https://www.gazco.com/huntingdonelectric)



Huntingdon 40 Electric with Clear Door in Matt Black with Log & Pebble fuel effect and Amber flame setting. Shown with Claremont Limestone Mantel.





Contemporary Stoves

Our contemporary stove collection presents captivating designs with elegant, minimalist styling. Adding a signature piece to any setting these designer stoves feature expansive viewing windows for an uninterrupted view of the flames.

Loft	32 - 39
Vogue	40 - 49
Vision	50 - 57
Studio Freestanding	58 - 61

Loft | Gas Stove Range

Clear-cut lines and sleek surfaces ensure the Loft's pure design creates a striking focal point in your interior. Reflective black glass frames the stove's tall firebox, subtly contrasting with the matt steel body. Soaring flames dance amongst a highly realistic fuel bed, composed of hand painted logs which are mirrored on all sides by the EchoFlame™ Black glass lining.



Luxurious Styling Possibilities

Loft stoves can be styled with a variety of accessories. Choose from cleanly styled Plinth and Logstore bases, with either option offered in matching steel, as well as smart Castillo grey sandstone or luxurious Woodgrain sandstone.

There is also a wall mounted version, for an ultra-modern floating installation that lends itself perfectly to contemporary settings. Regardless of the mounting options selected, the stove's height can be accentuated with a striking matching steel top section, hiding the flue pipe and continuing the stove's clean lines.



	kW HEAT OUTPUT RANGE	E% EFFICIENCY	EFFICIENCY CLASS	BRICK CHIMNEY	PRE-FABRICATED	BALANCED FLUE	WALL MOUNTING OPTION
Conventional Flue	2.00 - 4.40kW	78%	D	✓	✓	✗	✗
Balanced Flue	2.40 - 4.50kW	94.3%	A	✗	✗	✓	✓

Optional Linerless Flue Kit

The Loft is also compatible with our optional linerless flue kit. This eliminates the need for the chimney to be fully lined and any associated labour, facilitating a simpler and more cost effective solution. For information see page 64.



SEE IT BURNING AT:
gazco.com/loft

Loft Gas Steel Styling Options

The Loft can be tailored to your home with a host of styling options including Plinth and Logstore bases in matching matt black steel. A tall hood can also be added to accentuate the stove's height.



Loft with Steel Plinth

	Heat Output & Efficiency			Chimney or Flue Options			Fuel Bed	Lining	Control	Styling Options				
	kW HEAT OUTPUT RANGE	E% EFFICIENCY	E EFFICIENCY CLASS	BRICK CHIMNEY	PRE-FABRICATED	BALANCED FLUE	LOGS	ECHOFLAME BLACK GLASS	PROGRAMMABLE THERMOSTATIC REMOTE	STEEL PLINTH & LOG STORE BASE	STEEL TOP SECTION	SANDSTONE PLINTH & LOG STORE BASE	WALL MOUNTING OPTION	STOVE BENCH OPTION
Conventional Flue	2.00 - 4.40kW	78%	D	✓	✓	✗	✓	✓	✓ Page 66	✓ Page 34	✓ Page 33	✓ Page 36	✗	✓ Page 62
Balanced Flue	2.40 - 4.50kW	94.3%	A	✗	✗	✓	✓	✓	✓ Page 66	✓ Page 34	✓ Page 33	✓ Page 36	✓ Page 38	✓ Page 62

Efficiency figures given are based upon the maximum heat output achieved for these models. For additional information, specifications and complete model choices, please see pages 64 onwards.

See pages 5, 30-33, 63 & 74 for additional images

SEE IT BURNING AT:
gazco.com/loft





SEE IT BURNING AT:
[gazco.com/loft](https://www.gazco.com/loft)



Loft Gas Stone Base Options

The Loft's Plinth and Midline base options are also available in a choice of Castillo or Woodgrain sandstone. Each stone Plinth and Midline base is cut from natural sandstone for a beautifully unique appearance.

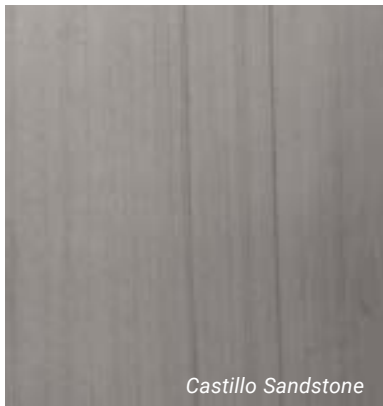
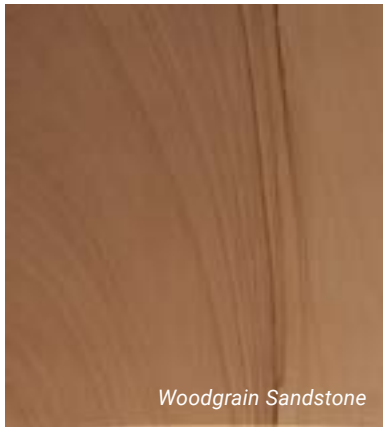

	Heat Output & Efficiency			Chimney or Flue Options			Fuel Bed	Lining	Control	Styling Options				
	HEAT OUTPUT RANGE	EFFICIENCY	EFFICIENCY CLASS	BRICK CHIMNEY	PRE-FABRICATED	BALANCED FLUE	LOGS	ECHOFLAME BLACK GLASS	PROGRAMMABLE THERMOSTATIC REMOTE	STEEL PLINTH & LOG STORE BASE	STEEL TOP SECTION	SANDSTONE PLINTH & LOG STORE BASE	WALL MOUNTING OPTION	STOVE BENCH OPTION
Conventional Flue	2.00 - 4.40kW	78%	D	✓	✓	✗	✓	✓	✓ Page 66	✓ Page 34	✓ Page 33	✓ Page 36	✗	✓ Page 62
Balanced Flue	2.40 - 4.50kW	94.3%	A	✗	✗	✓	✓	✓	✓ Page 66	✓ Page 34	✓ Page 33	✓ Page 36	✓ Page 38	✓ Page 62

Efficiency figures given are based upon the maximum heat output achieved for these models. For additional information, specifications and complete model choices, please see pages 64 onwards.

See page 74 for additional image

Loft Gas Wall Mounted

The balanced flue Loft can be mounted on the wall to achieve an alternative, 'floating' installation, which can be styled with the matching top section if desired. Top or rear flue options offer further installation versatility.

Loft with optional Wall Mounting Bracket



		Heat Output & Efficiency			Chimney or Flue Options			Fuel Bed	Lining	Control	Styling Options			
		kW HEAT OUTPUT RANGE	E% EFFICIENCY	A EFFICIENCY CLASS	BRICK CHIMNEY	PRE-FABRICATED	BALANCED FLUE	LOGS	ECHOFLAME BLACK GLASS	PROGRAMMABLE THERMOSTATIC REMOTE	STEEL PLINTH & LOG STORE BASE	STEEL TOP SECTION	SANDSTONE PLINTH & LOG STORE BASE	WALL MOUNTING OPTION
Balanced Flue		2.40 - 4.50kW	94.3%	A	X	X	✓	✓	✓	✓ Page 66	✓ Page 34	✓ Page 33	✓ Page 36	✓ Page 38

Efficiency figures given are based upon the maximum heat output achieved for these models. For additional information, specifications and complete model choices, please see pages 64 onwards.



Vogue Midi Gas

Classic-meets-contemporary, the elegant Vogue Midi lends itself to all interior styles with its bevelled edges and refined curves. For increased presence, Midline models offer a woodstore base to complement the woodburning aesthetic.



Gas Vogue Midi Midline

	Heat Output & Efficiency			Chimney or Flue Options			Fuel Bed	Lining	Control Options (Page 66)			Styling	Optional Linerless Flue Kit
	kW HEAT OUTPUT RANGE	E% EFFICIENCY	EFFICIENCY CLASS	BRICK CHIMNEY	PRE-FABRICATED	BALANCED FLUE	LOGS	ECHOFLAME BLACK GLASS	MANUAL	STANDARD UPGRADEABLE REMOTE	PROG. THERMOSTATIC UPGRADEABLE REMOTE	STOVE BENCH OPTION	
Conventional Flue	1.60 - 4.30kW	76%	E	✓	✓	✗	✓	✓	✓	✓	✓	✓ Page 62	<i>This option eliminates the need for the chimney to be fully lined and any associated labour, facilitating a simpler, more cost effective solution. For more details see page 64.</i>
Balanced Flue	1.80 - 4.00kW	90.6%	B*	✗	✗	✓	✓	✓	✓	✓	✓	✓ Page 62	

Efficiency figures given are based upon the maximum heat output achieved for these models. For additional information, specifications and complete model choices, please see pages 64 onwards.

* When using Programmable Thermostatic Remote

See page 46 for electric models

SEE IT BURNING AT:
gazco.com/voguemidigas





SEE IT BURNING AT:
gazco.com/voguemitgas



Vogue Midi T Gas

Taking the elegant styling of the smaller Midi range, the Midi T's bevelled cast iron exterior encases a taller firebox that offers a three-sided view of the impressive visuals. This contemporary stove is also available in Midline and Highline versions, which feature stylish log store bases to add to the wood fire aesthetic.



Gas Vogue Midi T



Gas Vogue Midi T Highline

	Heat Output & Efficiency	Chimney or Flue Options	Fuel Bed	Lining	Control Options (Page 66)	Styling Options	Optional Linerless Flue Kit							
	kW HEAT OUTPUT RANGE	E% EFFICIENCY	E EFFICIENCY CLASS	BRICK CHIMNEY	PRE-FABRICATED	BALANCED FLUE	LOGS	ECHOFLAME BLACK GLASS	MANUAL	STANDARD UPGRADEABLE REMOTE	PROGRAMMABLE THERMOSTATIC UPGRADEABLE REMOTE	WALL MOUNTING OPTION	STOVE BENCH OPTION	
Conventional Flue	2.00 - 4.40kW	78%	E	✓	✓	✗	✓	✓	✓	✓	✓	✗	✓ Page 62	This option eliminates the need for the chimney to be fully lined and any associated labour, facilitating a simpler, more cost effective solution. For details see page 64.
Balanced Flue	2.40 - 4.80kW	94.3%	A*	✗	✗	✓	✓	✓	✓	✓	✓	✓ Page 44	✓ Page 62	

Efficiency figures given are based upon the maximum heat output achieved for these models. For additional information, specifications and complete model choices, please see pages 64 onwards.

* When using Programmable Thermostatic Remote

Vogue Midi T Gas Wall Mounted

For an alternative installation the Midi T Wall Mounted makes for a strikingly contemporary statement. This floating installation can be either rear or top flued depending on your preferences.



Gas Vogue Midi T Wall Mounted



Gas Vogue Midi T Wall Mounted

	Heat Output & Efficiency			Chimney or Flue Options			Fuel Bed	Lining	Control Options (Page 66)			Styling Options
	HEAT OUTPUT RANGE	EFFICIENCY	EFFICIENCY CLASS	BRICK CHIMNEY	PRE-FABRICATED	BALANCED FLUE	LOGS	ECHOFLAME BLACK GLASS	MANUAL	STANDARD UPGRADEABLE REMOTE	PROG. THERMOSTATIC UPGRADEABLE REMOTE	WALL MOUNTING OPTION
Balanced Flue	2.40 - 4.80kW	94.3%	A*	X	X	✓	✓	✓	✓	✓	✓	✓ Page 42



See page 48 for electric models

Efficiency figures given are based upon the maximum heat output achieved for these models. For additional information, specifications and complete model choices, please see pages 64 onwards.

* When using Programmable Thermostatic Remote





SEE IT BURNING AT:

gazco.com/vogueelectric



Vogue Midi Electric

Available in two models including the Midline log store version, the Vogue Midi offers a choice of fuel beds as standard including logs, pebbles & crystal-effects, letting you mix and match to create a truly bespoke display.



	Heat Output	Interchangeable Fuel Beds		Lighting Effects			Control	Styling
	kW HEAT OUTPUT RANGE	LOG AND PEBBLE	CRYSTAL ICE EFFECT	CHROMALIGHT IMMERSIVE LED SYSTEM	MULTIPLE FLAME EFFECTS	13 FUEL BED LIGHTING COLOURS	PROGRAMMABLE THERMOSTATIC ECO REMOTE	STOVE BENCH OPTION
Vogue Midi Electric	0.75 - 1.50kW or flame effect only	✓	✓	✓	✓	✓	✓ Page 66	✓ Page 62

For additional information, specifications and complete model choices, please see pages 64 onwards.

See page 66 for additional image

See page 40 for gas models

Vogue Midi T Electric

A collection of tall contemporary stoves. Each featuring windows on either side of the stylish stove body to supplement the large front window ensuring the display is visible from almost any angle.



Vogue Midi T Electric with Log & Pebble fuel effects and Amber and Blue accent flame setting.



Vogue Midi T Midline Electric with Log & Pebble Fuel effects and Amber flame setting



Vogue Midi T Wall Hung Electric with Log & Pebble fuel effects and Amber and Blue accent flame setting.

	Heat Output	Interchangeable Fuel Beds		Lighting Effects			Control	Styling Options	
	kW HEAT OUTPUT RANGE	 LOG AND PEBBLE	 CRYSTAL ICE EFFECT	 CHROMALIGHT IMMERSIVE LED SYSTEM	 MULTIPLE FLAME EFFECTS	 13 FUEL BED LIGHTING COLOURS	 PROGRAMMABLE THERMOSTATIC ECO REMOTE	 WALL MOUNTING OPTION	 STOVE BENCH OPTION
Vogue Midi T Electric	0.75 - 1.50kW or flame effect only	✓	✓	✓	✓	✓	✓ Page 66	✓	✓ Page 62

For additional information, specifications and complete model choices, please see pages 64 onwards.

See rear cover for additional image

See page 42-45 for gas models

SEE IT BURNING AT:
[gazco.com/voguemiditelectric](https://www.gazco.com/voguemiditelectric)



Vogue Midi T Highline Electric with Log & Pebble
Fuel effects and Amber flame setting



SEE IT BURNING AT:

gazco.com/visionsmallgas



Vision Small Gas

The Gas Vision Small offers beautiful, contemporary aesthetics in a neat package – well suited to standard chimney openings thanks to its compact proportions.



Gas Vision Small on 100 Low Bench

	Heat Output & Efficiency			Chimney or Flue Options			Fuel Bed	Lining	Control Options (Page 66)			Styling
	HEAT OUTPUT RANGE	EFFICIENCY	EFFICIENCY CLASS	BRICK CHIMNEY	PRE-FABRICATED	BALANCED FLUE	LOGS	VERMICULITE	MANUAL	STANDARD UPGRADEABLE REMOTE	PROG. THERMOSTATIC UPGRADEABLE REMOTE	STOVE BENCH OPTION
Conventional Flue	1.20 - 2.30kW	76%	E	✓	✓	✗	✓	✓	✓	✓	✓	✓ Page 62
Balanced Flue	1.20 - 2.50kW	85.1%	C*	✗	✗	✓	✓	✓	✓	✓	✓	✓ Page 62



See page 57 for electric models

Efficiency figures given are based upon the maximum heat output achieved for these models. For additional information, specifications and complete model choices, please see pages 64 onwards.

* When using Programmable Thermostatic Remote



SEE IT BURNING AT:
gazco.com/visionmidigas



Vision Midi Gas

With its pure lines and stylish black glass surfaces, the Gas Vision Midi brings the age old concept of the stove into the present day, offering wood fire ambience with clean, modern styling.



Gas Vision Midi

	Heat Output & Efficiency			Chimney or Flue Options			Fuel Bed	Lining	Control Options (Page 66)			Styling
	HEAT OUTPUT RANGE	EFFICIENCY	EFFICIENCY CLASS	BRICK CHIMNEY	PRE-FABRICATED	BALANCED FLUE	LOGS	VERMICULITE	MANUAL	STANDARD UPGRADEABLE REMOTE	PROG. THERMOSTATIC UPGRADEABLE REMOTE	STOVE BENCH OPTION
Conventional Flue	1.50 - 3.10kW	75%	E	✓	✓	✗	✓	✓	✓	✓	✓	✓ Page 62
Balanced Flue	2.10 - 3.80kW	95.4%	A*	✗	✗	✓	✓	✓	✓	✓	✓	✓ Page 62



See page 56 for electric models

See page 62 for additional image

Efficiency figures given are based upon the maximum heat output achieved for these models. For additional information, specifications and complete model choices, please see pages 64 onwards.

* When using Programmable Thermostatic Remote

Vision Medium Gas

The Gas Vision Medium is the largest model in the Vision range with a powerful heat output to match, making it a great choice for installing into expansive inglenook fireplaces or bigger rooms.



	Heat Output & Efficiency			Chimney or Flue Options				Fuel Bed	Lining	Control Options (Page 66)			Styling
	HEAT OUTPUT RANGE	EFFICIENCY	EFFICIENCY CLASS	BRICK CHIMNEY	PRE-FABRICATED	BALANCED FLUE	LOGS	VERMICULITE	MANUAL	STANDARD UPGRADEABLE REMOTE	PROG. THERMOSTATIC UPGRADEABLE REMOTE	STOVE BENCH OPTION	
Conventional Flue	1.80 - 4.80kW	78%	E	✓	✓	✗	✓	✓	✓	✓	✓	✓ Page 62	
Balanced Flue	2.70 - 5.50kW	90.8%	B*	✗	✗	✓	✓	✓	✓	✓	✓	✓ Page 62	

Efficiency figures given are based upon the maximum heat output achieved for these models. For additional information, specifications and complete model choices, please see pages 64 onwards.

* When using Programmable Thermostatic Remote



See page 57 for electric models



SEE IT BURNING AT:
gazco.com/voguemediumgas



SEE IT BURNING AT:
gazco.com/visionelectric



Vision Electric

The Vision is a contemporary, electric, with each size sporting a highly reflective black glass door, integral glass plinth, black glass top plate and stainless steel detailing for a clean stylish look.



	Heat Output	Interchangeable Fuel Beds		Lighting Effects			Control	Styling
	HEAT OUTPUT RANGE	LOG AND PEBBLE	CRYSTAL ICE EFFECT	CHROMALIGHT IMMERSIVE LED SYSTEM	MULTIPLE FLAME EFFECTS	13 FUEL BED LIGHTING COLOURS	PROGRAMMABLE THERMOSTATIC ECO REMOTE	STOVE BENCH OPTION
Vision Electric Small, Midi & Medium	1.00 - 2.00kW or flame effect only	✓	✓	✓	✓	✓	✓	✓ Page 62

For additional information, specifications and complete model choices, please see pages 64 onwards.

See page 62 for additional image

See page 50-55 for gas models

Studio 1 Freestanding Gas

A designer gas stove with a wide range of styling options, the Studio 1 Freestanding transforms your home to offer the very best in relaxing ambience.



	Heat Output & Efficiency			Chimney or Flue Options			Fuel Bed Options			Lining Options			Control	Styling Options	
	kW HEAT OUTPUT RANGE	E% EFFICIENCY	E EFFICIENCY CLASS	BRICK CHIMNEY	PRE-FABRICATED	BALANCED FLUE	LOGS	DRIFTWOOD	PEBBLE & STONE	ECHOFLAME BLACK GLASS	VERMICULITE	BLACK REEDED	PROGRAMMABLE THERMOSTATIC REMOTE	WHITE OR BLACK FINISH	PLINTH OR BENCH MOUNTING OPTIONS
Conventional Flue	2.00 - 4.60kW	72%	E	✓	✓	✗	✓	✓	✓	As standard	Optional	Optional	✓ Page 66	✓	✓
Balanced Flue	3.00 - 5.30kW	90.8%	A	✗	✗	✓	✓	✓	✓	As standard	Optional	Optional	✓ Page 66	✓	✓

Efficiency figures given are based upon the maximum heat output achieved for these models. For additional information, specifications and complete model choices, please see pages 64 onwards.

See page 76 for additional image

SEE IT BURNING AT:
gazco.com/studio1freestandinggas



Studio 1 Freestanding conventional flue with Black front and matching bench, Pebble & Stone fuel bed and EchoFlame Black Glass lining



SEE IT BURNING AT:

gazco.com/studio2freestandinggas



Studio 2 Freestanding Gas

The landscape Studio 2 Freestanding offers an expansive view of the realistic flames and can be customised with a black or white steel front, as well as a choice of either matching plinth or bench.



Studio 2 Freestanding conventional flue with Black front and matching plinth, Log-effect fuel bed and EchoFlame Black Glass lining

	Heat Output & Efficiency			Chimney or Flue Options			Fuel Bed Options			Lining Options			Control	Styling Options	
	kW HEAT OUTPUT RANGE	E% EFFICIENCY	EFFICIENCY CLASS	BRICK CHIMNEY	PRE-FABRICATED	BALANCED FLUE	LOGS	DRIFTWOOD	PEBBLE & STONE	ECHOFLAME BLACK GLASS	VERMICULITE	BLACK REEDED	PROGRAMMABLE THERMOSTATIC REMOTE	WHITE OR BLACK FINISH	PLINTH OR BENCH MOUNTING OPTIONS
Conventional Flue	3.20 - 7.00kW	81%	C	✓	✓	✗	✓	✓	✓	As standard	Optional	Optional	✓	✓	✓
Balanced Flue	2.70 - 6.30kW	92%	A	✗	✗	✓	✓	✓	✓	As standard	Optional	Optional	✓	✓	✓

Efficiency figures given are based upon the maximum heat output achieved for these models. For additional information, specifications and complete model choices, please see pages 64 onwards.

See page 77 for additional image

Stove Benches

These versatile steel benches are compatible with the Loft, Vision and Vogue Stoves. With a variety of sizes they offer greater design possibilities such as central or offset stove positioning, expanding your styling options.



Product Code	Bench	W (mm)	H (mm)	D (mm)
RVACLB45BHT	45 Low bench	450	250	420
RVACB45BHT	45 High bench	450	350	420
RVACLB100BHT	100 Low bench	1000	250	420
RVACB100BHT	100 High bench	1000	350	420
RVACLB120BHT	120 Low bench	1200	250	420
RVACB120BHT	120 High bench	1200	350	420
RVACLB140BHT	140 Low bench	1400	250	420
RVACB140BHT	140 High bench	1400	350	420
RVACLB180BHT	180 Low bench	1800	250	465
RVACB180BHT	180 High bench	1800	350	465
Deeper Bench Options (500mm Deep)				
RVACLB120BHT	120 Low bench (500mm deep)	1200	250	500
RVACB120BHT	120 High bench (500mm deep)	1200	350	500
RVACLB140BHT	140 Low bench (500mm deep)	1400	250	500
RVACB140BHT	140 High bench(500mm deep)	1400	350	500
RVACLB180BHT	180 Low bench (500mm deep)	1800	250	500
RVACB180BHT	180 High bench (500mm deep)	1800	350	500



Gas Vogue Midi T on 100 Low Bench



Gas Vision Midi on 45 Low Bench



Electric Vision Midi with Log and Pebble Fuel effects and Amber flame setting on 100 High Bench



Loft on 120 High Bench

Your Home and Flue Requirements

When selecting your stove, your local Gazco retailer will need to make sure it's suitable for your home. Firstly, you need to know what fuel type you will be using. Secondly, you will need to be aware of what type of chimney or flue you have. If you do not have a chimney then don't worry, Gazco have models developed to suit your home too!

Conventional Flue - Gas

Conventional flue systems are easily recognisable as either a conventional brick or stone chimney or pre-fabricated chimney system. Should your home have none of these at present, it is usually possible to have a pre-fabricated system installed if required.



Brick or Stone Chimney
(Class 1)

The chimney stack rises well above the roofline and is topped by a traditional chimney pot or gas terminal. This type of chimney relies on the natural circulation of heated air to expel the products of combustion up your chimney.



Pre-Fabricated Flues
(Class 1 & 2)

You will see a metal flue cowl on your roof. Some are all metal whilst others may terminate through a short rectangular pot (but without a chimney stack). These flues create the same circulation of heated air as a brick or stone chimney.

Rigid or Flexible Metal Flue Systems

With this flue system rigid metal tubes, or a combination of rigid and flexible metal tubes, extend vertically directly from the stove to the outside of the property. This may be either straight through the ceiling or roof with the flue pipe exposed, or by using the channel of a chimney or a studwork enclosure. The products of combustion are carried up the flue by natural convection.

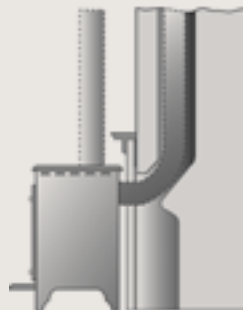

Optional Linerless Flue Kit

A selection of conventional flue gas stoves are compatible with our optional linerless flue kit. At just 0.5 metres long, this short piece of flexible, stainless steel flue pipe and debris deflector has been specifically designed to be slotted into your masonry chimney. This eliminates the need for the chimney to be fully lined and any associated labour, facilitating a simpler and more cost effective solution.

The Optional Linerless Flue Kit is compatible with:

- Sheraton 5 Gas
- Vogue Midi Gas Range
- Vogue Midi T Gas Range
- Loft Range

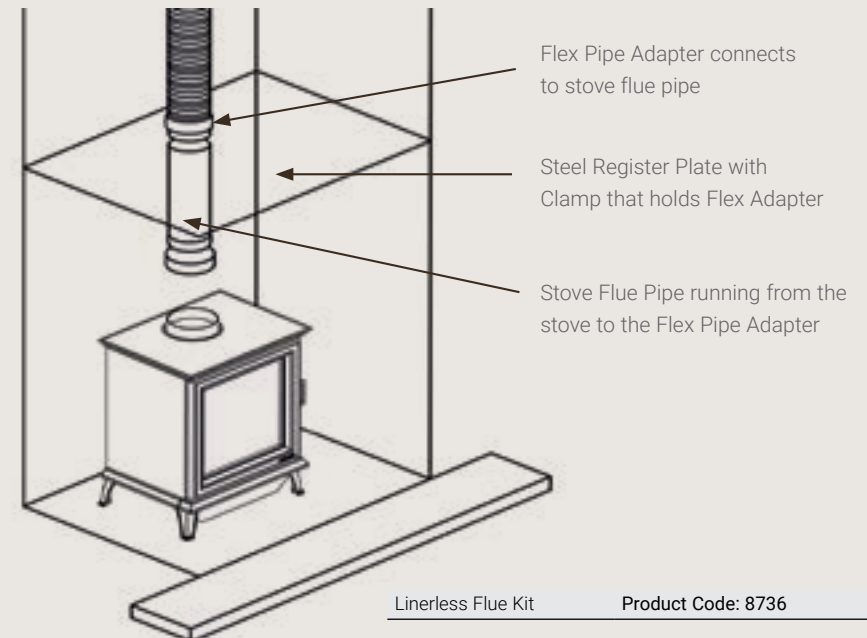

Balanced Flue - Gas

Balanced flues models are completely sealed from the room into which they are installed (so there are no draughts and heating efficiency is increased) and a twin-wall pipe vents directly to an outside wall.



Balanced Flue
(No chimney required)

Air for combustion is drawn in through the outer pipe whilst the inner pipe removes the combustion gases to the exterior of the property. Depending on the stove selected, the twin-walled pipe may exit horizontally through an external wall or vertically through the roof. Gazco offers a comprehensive range of balanced flue system components.



Balanced Flue System Options

- A** - Rear outlet (max 600mm wall thickness).
- B** - Top outlet/up and out (min rise 500mm, max 3m), horizontal (min 250mm, max 5m). An additional bend can be incorporated in to the horizontal section of the 'up and out', dependent upon a 1m min vertical rise.
- C** - Top outlet/vertical (min 3m, max 10m). Vogue Midi T / Vogue Midi T Midline (Min 2m, Max 10m)
- D** - Top outlet/vertical with offset (min to first bend 500mm, max flue length 10m).



Ask your retailer for full technical details or see our Balanced Flue System brochure at www.gazco.com.

Electric Stoves

(No chimney required)

Our range of electric stoves incorporates our Chromalight Immersive LED technology and do not have any chimney or flue requirements. From the contemporary collection of Vision to the more traditional Sheraton models, these electric fires can be enjoyed with or without the heat and operated using a remote control, so you can enjoy the warmth and ambience from the comfort of your favourite chair!



No Air Vent Required (UK)

All stoves shown with this symbol, boast the advantage of not normally requiring an air vent* where the air permeability is greater than 5.0m³/hr/m². Please discuss this in full with your local Gazco retailer.



**Requirements in the Republic of Ireland are different.*

Loft with Woodgrain
Sandstone Log Store



Remote Controls

Gas Stoves

Gazco was the first UK company to introduce remote controls for gas fires. Today, our remote control systems allow most stoves to be upgraded, either at the time of purchase or at a later date, with either:

Standard upgradeable remote control



Once the pilot light has been ignited manually you can vary the flame height and heat output from the comfort of your armchair.

(Upgradeable option for Marlborough2, Stockton, Huntingdon, Vogue and Vision gas stoves)

Programmable Thermostatic upgradeable remote control



This deluxe version has two additional features. The first allows you to thermostatically control the room temperature whilst the second allows you to programme your stove to switch itself on and off twice a day.

(Upgradeable option for Marlborough2, Stockton, Huntingdon, Vogue and Vision gas stoves)

Programmable Thermostatic remote control *(Supplied with Loft & Studio Freestanding)*



This advanced remote is loaded with exciting features that make it possible to programme your stove to perfectly complement your lifestyle. Not only can you ignite, extinguish and thermostatically control your stove, this remote control system benefits from advanced technology that gives you the option to create an automatic, intelligent heating program that means your home is comfortable and cosy at any time of the day or night.

Fully-sequential thermostatic remote control *(Supplied with Gas Sheraton 5)*



The Sheraton 5 Gas features Gazco's fully-sequential thermostatic control system, which allows you to ignite your stove in seconds as well as adjust flame height from the comfort of your sofa. You can also set your stove to be controlled thermostatically to maintain your preferred room temperature.

Electric Stoves

Our range of Electric Stoves are as easy to install as plugging in and switching on! They are available in a range of designs from traditional to modern, to suit all homes and tastes.

The Gazco Programmable Thermostatic Eco Handset



All Gazco Electric stoves features Gazco's Eco remote control, which provides complete control over the stove's ChromaLight flame colours and lighting effects, as well as heating and energy saving features. Ambient heating control allows you to set the optimum temperature for your room between 15°C and 25°C, with the Vogue automatically managing heating power to reach the chosen temperature as efficiently as possible. Daily and weekly heating lets you program your stove to suit your lifestyle and can be easily advanced or delayed without disrupting scheduling.

Energy saving features such as Open Window Detection save energy by turning off the heat if a sudden drop in room temperature of 4°C or more is detected, for example when a door or window is opened. Heating can be easily resumed by pressing the heat button again or closing the window.



Vogue Midi Electric with Crystal-Ice fuel effect on Blue flame setting

Additional Information

Product Improvement & Brochure Photography

Gazco pursue a policy of continuous product improvement, therefore, whilst our products are correct at the time of the photography, we reserve the right to make alterations and amendments. Exact product details should be discussed with your retailer at the time of purchase.

All fire and flame photography has been taken from genuine products; however, the exact appearance of the flame picture for any appliance will vary depending on the nature of the flue type, installation surroundings, local geographical features and the way in which the appliance is operated. Owing to variations in studio lighting and printing inks, the colours of stoves illustrated in this brochure may differ slightly from actual models.

Given that building regulations are subject to constant change, some of the photography in this brochure may not comply with the requirements of the latest Building Regulations and you should always check your proposed installation arrangement with your qualified gas installer before proceeding. Certain settings in this brochure are dependent on the use of heat shields to reduce the required separation from combustible material.

Please note: The operation and appearance of gas appliances depends on variable factors such as the gas pressure supplied.

Installation and Safety

Gazco gas stoves must be fitted by a qualified gas installer (Gas Safe registered in the United Kingdom or Bord Gais registered in the Republic of Ireland) who should also verify the proposed site conditions are fully suitable for the product selected. Complete installation instructions for many models can be obtained prior to purchase by downloading them from www.gazco.com.

Please note that all parts of these stoves become extremely hot during operation and can result in serious injury and burns if touched. It is therefore recommended that a fireguard complying with BS 8423:2002 is used in the presence of young children, the elderly or infirm.

Technical Specifications

All specifications given in the main part of this brochure are approximate. Actual specifications for each individual product will vary according to the exact model and are given on pages 68 - 77. Your Gazco retailer will be pleased to help explain specific model specifications and provide any further information you may require, or you can view/download specification sheets from www.gazco.com.

Warranty information

Your Gazco Expert Retailer will provide you with a Two Year Warranty for your new gas or electric stove. The warranty for gas stoves can be extended to a period of Five years by registering your stove with Gazco. Please note, these warranties exclude certain consumable parts. Stoves purchased outside of Gazco's Expert Retailer Network will carry a standard One Year non-extendable Warranty.



Full warranty terms and conditions are available to view at www.gazco.com.

WIN
the cost of your product back!

For further home inspiration you can **view real life installations** at our **Customer Showcase** page and share your thoughts and photos of your new stove or fire installation to enter our draw!

- We will publish your entry on our Customer Showcase
- You will be entered into a draw for the chance to win the cost of your product back
- **Gain a second entry** by registering your product online for your free extended warranty at gazco.com/registration

"So pleased we chose this gas alternative to a log burning stove"

View real life installations and submit your review at
gazco.com/customershowcase

* Terms and conditions apply. See online for details

Technical Information

The below information is to assist in your choice of a suitable Gazco stove. This is not intended to be all the information required to install your stove. This can be obtained from your local Gazco retailer or you can download the full installation instructions at www.gazco.com

Sheraton 5 Gas and Electric

Dimensions (mm)

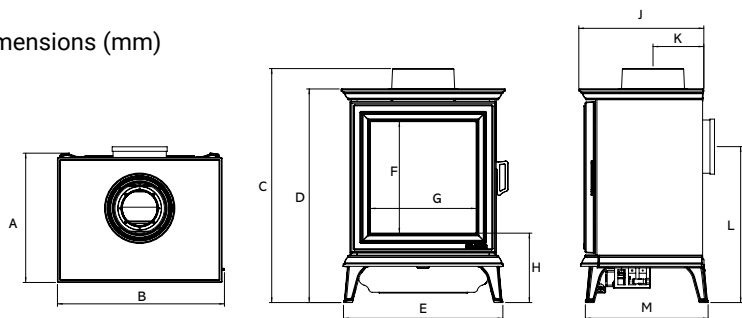

	A	B	C	D	E	F	G	H	J	K	L	M	Weight
Sheraton 5 Gas (CF)	371	479	650	613	457	320	304	199	359	129	456	352	61kg
Sheraton 5 Gas (BF)	371	479	672	613	457	320	304	199	359	145	447	352	62kg
Sheraton 5 Electric	371	480	-	614	-	320	304	-	-	-	-	-	55kg

Recommended clearances between gas stove and other surfaces: top 9" (225mm), sides 6" (150mm), rear must be a minimum of 2" (50mm).

Product Code	Colour	Flue Type	Fuel Type	Heat Input	Heat Output	Efficiency	Energy Efficiency Class
⊗ 505-014	Matt Black	Conventional	Nat.Gas	5.80kW	4.00kW	76%	D
⊗ 505-428	Matt Black	Conventional	LPG	5.40kW	3.80kW	76%	D
⊗ 505-215	Matt Black	Balanced	Nat.Gas	4.70kW	3.80kW	90.6%	B
⊗ 505-537	Matt Black	Balanced	LPG	4.80kW	4.00kW	90.6%	B
⊗ 605-832	Matt Black	-	Electric	-	1.50kW	-	-

Options for Gas Sheraton 5

Options for Gas Sheraton 5	Product Code
Linerless Flue Kit	8736

Stove Flue Pipe

1' Straight pipe	4500
2' Straight pipe	4501
3' Straight pipe	4502
90° long 'elbow' adaptor (9" projection)	4514

Stove Flue Pipe Balanced flue versions of the Gas Sheraton 5 must only use the 6" stainless steel flue provided. Gazco recommends the use of 5" matt black enamelled stove pipe with the conventional flue version Sheraton 5 stove.

Marlborough2 Gas and Electric

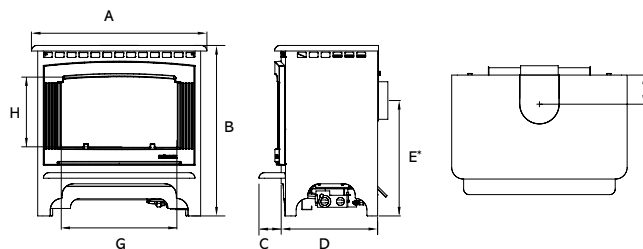

Recommended clearances between stove and other surfaces: top 9" (225mm), sides 6" (150mm), rear must be a minimum of 2" (50mm).

* Small balanced flue models are rear flue exit only

Dimensions (mm)

	A	B	C	D	E	F	G	H	Weight
Small Marlborough2 Gas (CF)	429	533	75	280	349	110	232	211	35kg
Medium Marlborough2 Gas (CF)	600	583	76	330	395	103	232	211	57kg
Small Marlborough2 Gas (BF)*	429	533	75	280	369	110	398	241	36kg
Medium Marlborough2 Gas (BF)	600	583	76	330	445	129	398	241	67kg
Small Marlborough2 Electric	429	558	75	280	-	-	232	211	33kg
Medium Marlborough2 Electric	600	583	76	330	-	-	398	241	50kg

Product Code	Model	Colour	Flue Type	Fuel Type	Heat Input	Heat Output	Efficiency	Energy Efficiency Class
⊗ 559-009	Small	Matt Black	Conventional	Nat.Gas	3.30kW	2.30kW	76%	E
⊗ 559-448	Small	Matt Black	Conventional	LPG	3.20kW	2.20kW	76%	E
⊗ 559-024	Small	Matt Black	Balanced	Nat.Gas	3.20kW	2.50kW	85.1%	C#
⊗ 559-462	Small	Matt Black	Balanced	LPG	3.10kW	2.40kW	85.1%	C#
⊗ 559-018	Medium	Matt Black	Conventional	Nat Gas	6.60kW	4.60kW	78%	E
⊗ 559-456	Medium	Matt Black	Conventional	LPG	6.70kW	4.80kW	78%	E
⊗ 559-033	Medium	Matt Black	Balanced	Nat Gas	6.60kW	5.40kW	90.8%	B#
⊗ 559-471	Medium	Matt Black	Balanced	LPG	6.60kW	5.50kW	90.8%	B#
⊗ 659-085	Small	Matt Black	-	Electric	-	2.00kW	-	-
⊗ 659-112	Medium	Matt Black	-	Electric	-	2.00kW	-	-

Gas Remote Control Options

Gas Remote Control Options	Product Code
Standard Upgradeable Remote Control	8455
Programmable Thermostatic Upgradeable Remote Control	8456

When upgraded with a Programmable Thermostatic Control (8456)

Stove Flue Pipe & Flue Collars

1' Straight pipe	4500
2' Straight pipe	4501
3' Straight pipe	4502
90° long 'elbow' adaptor (9" projection)	4514
Optional Top Exit Flue Collar (CF)	8549
Optional Top Exit Flue Collar (BF)	8548

Stove Flue Pipe Balanced flue versions of the Gas Marlborough2 must only use the 6" stainless steel flue provided. Gazco recommends the use of 5" matt black enamelled stove pipe with the conventional flue version Marlborough2 stove.

Technical Information

The below information is to assist in your choice of a suitable Gazco stove. This is not intended to be all the information required to install your stove. This can be obtained from your local Gazco retailer or you can download the full installation instructions at www.gazco.com

Stockton2 & Stockton 5 Gas and Electric

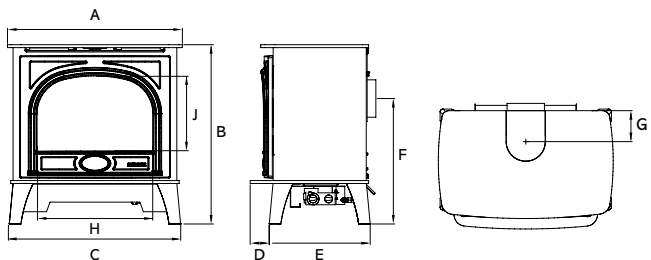

Recommended clearances between stove and other surfaces: top 9" (225mm), sides 6" (150mm), rear must be a minimum of 2" (50mm).

*Small balanced flue stoves are rear exit only.

Dimensions (mm)

	A	B	C	D	E	F	G	H	J	Weight
Small Stockton2 Gas (CF)	438	525	418	50	290	348	111	232	220	52kg
Stockton 5 Gas (CF)	481	544	-	64	273	380	92	267	212	55kg
Medium Stockton2 Gas (CF)	601	617	589	65	347	432	107	398	258	78.5kg
Small Stockton2 Gas (BF)*	438	525	418	50	290	368	111	232	220	53kg
Stockton 5 Gas (BF)	481	544	-	64	273	401	139	267	212	55kg
Medium Stockton2 Gas (BF)	601	617	589	65	347	482	136	398	258	87kg
Small Stockton2 Electric	438	525	418	50	290	-	-	232	220	50kg
Stockton 5 Electric	481	544	-	64	273	-	-	-	-	55kg
Medium Stockton2 Electric	601	617	589	65	347	-	139	398	258	72kg

Product Code	Model	Colour	Flue Type	Fuel Effect	Fuel Type	Heat Input	Heat Output	Efficiency	Energy Efficiency Class
⊗ 504-053	Small	Matt Black	Conventional	Logs	Nat Gas	3.30kW	2.30kW	76%	E
⊗ 504-513	Small	Matt Black	Conventional	Logs	LPG	3.20kW	2.20kW	76%	E
⊗ 504-078	Small	Matt Black	Balanced	Logs	Nat Gas	3.20kW	2.50kW	85.1%	C#
⊗ 504-536	Small	Matt Black	Balanced	Logs	LPG	3.10kW	2.40kW	85.1%	C#
⊗ 8575MCUC	5	Matt Black	Conventional	Coal	Nat Gas	4.60kW	3.00kW	73%	E
⊗ P8575MCUC	5	Matt Black	Conventional	Coal	LPG	4.40kW	3.00kW	73%	E
⊗ 8563LUC	5	Matt Black	Balanced	Logs	Nat Gas	4.25kW	3.50kW	91.8%	B#
⊗ P8563LUC	5	Matt Black	Balanced	Logs	LPG	4.10kW	3.50kW	84.5%	B#
⊗ 504-066	Medium	Matt Black	Conventional	Logs	Nat Gas	6.60kW	4.60kW	78%	E
⊗ 504-522	Medium	Matt Black	Conventional	Logs	LPG	6.70kW	4.80kW	78%	E
⊗ 504-085	Medium	Matt Black	Balanced	Logs	Nat Gas	6.60kW	5.40kW	90.8%	B*
⊗ 504-547	Medium	Matt Black	Balanced	Logs	LPG	6.60kW	5.50kW	90.8%	B#
⊗ 604-144	Small	Matt Black	-	Various	Electric	-	1.50kW	-	-
⊗ 604-172	5	Matt Black	-	Various	Electric	-	1.50kW	-	-
⊗ 604-203	Medium	Matt Black	-	Various	Electric	-	1.50kW	-	-



Gas Stockton 5 balanced flue with log-effect fire

Gas Remote Control Options

Product Code

Standard Upgradeable Remote Control	8455
Programmable Thermostatic Upgradeable Remote Control	8456

Stove Flue Pipe

1' Straight pipe	4500
2' Straight pipe	4501
3' Straight pipe	4502
90° long 'elbow' adaptor (9" projection)	4514
Optional Top Exit Flue Collar (CF)	8549
Optional Top Exit Flue Collar (BF)	8548

Stove Flue Pipe Balanced flue versions of the Gas Stockton must only use the 6" stainless steel flue provided. Gazco recommends the use of 5" Matt Black enamelled stove pipe with the conventional flue version.

When upgraded with a Programmable Thermostatic Control (8456)

Technical Information

The below information is to assist in your choice of a suitable Gazco stove. This is not intended to be all the information required to install your stove. This can be obtained from your local Gazco retailer or you can download the full installation instructions at www.gazco.com

Huntingdon 20 Gas and Electric

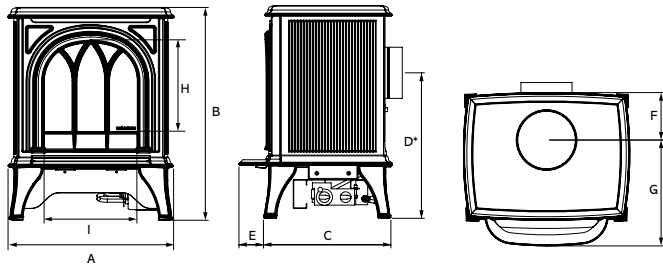

Recommended clearances between stove and other surfaces: top 9" (225mm), sides 6" (150mm), rear must be a minimum of 2" (50mm).

*Huntingdon 20 Balanced Flue is Rear Exit only.

Dimensions (mm)

	A	B	C	D	E	F	G	H	I	Weight
Huntingdon 20 Gas (CF)	416	535	320	366	62	119	266	223	234	45kg
Huntingdon 20 Gas (BF)*	416	535	320	386	62	160	225	223	234	45kg
Huntingdon 20 Electric	413	536	324	-	62	-	-	223	234	35kg

Remote Controls

	Product Code
Standard Upgradeable Remote Control	8455
Programmable Thermostatic Upgradeable Remote Control	8456

Stove Flue Pipe and Collars

1' Straight pipe, Matt Black	4500
2' Straight pipe, Matt Black	4501
3' Straight pipe, Matt Black	4502
90° long 'elbow' adaptor (9" projection), Matt Black	4514
1' Straight pipe, Ivory	4500IV
2' Straight pipe, Ivory	4501IV
3' Straight pipe, Ivory	4502IV
1' Straight pipe, Matt Ivory	4500PI
2' Straight pipe, Matt Ivory	4501PI
3' Straight pipe, Matt Ivory	4502PI
Matt Black Flue collar, Conventional Flue, Huntingdon	999-010
Matt Ivory Flue collar, Conventional Flue, Huntingdon	999-266
Ivory Enamel Flue collar, Conventional Flue, Huntingdon	999-456

Stove Flue Pipe Balanced flue versions of the Gas Huntingdon 20 must only use the 6" stainless steel flue provided. For additional Matt Black, Matt Ivory and Ivory enamelled flue collars, please see the Gazco Stoves price list. Gazco recommends the use of 5" Matt Black enamelled stove pipe with the conventional flue version.

Gas & Electric Huntingdon 20 Tracery Door

Product Code	Colour	Door Style	Flue Type	Fuel Type	Heat Input	Heat Output	Efficiency	Energy Efficiency Class
⊗ 515-035	Matt Black	Tracery	Conventional	Nat Gas	3.30kW	2.30kW	76%	E
⊗ 515-405	Matt Black	Tracery	Conventional	LPG	3.20kW	2.20kW	76%	E
⊗ 515-044	Ivory	Tracery	Conventional	Nat Gas	3.30kW	2.30kW	76%	E
⊗ 515-423	Ivory	Tracery	Conventional	LPG	3.20kW	2.20kW	76%	E
⊗ 515-053	Matt Ivory	Tracery	Conventional	Nat Gas	3.30kW	2.30kW	76%	E
⊗ 515-432	Matt Ivory	Tracery	Conventional	LPG	3.20kW	2.20kW	76%	E
⊗ 515-098	Matt Black	Tracery	Balanced	Nat Gas	3.20kW	2.50kW	85.1%	C#
⊗ 515-502	Matt Black	Tracery	Balanced	LPG	3.10kW	2.40kW	85.1%	C#
⊗ 515-107	Ivory	Tracery	Balanced	Nat Gas	3.20kW	2.50kW	85.1%	C#
⊗ 515-511	Ivory	Tracery	Balanced	LPG	3.10kW	2.40kW	85.1%	C#
⊗ 515-116	Matt Ivory	Tracery	Balanced	Nat Gas	3.20kW	2.50kW	85.1%	C#
⊗ 515-520	Matt Ivory	Tracery	Balanced	LPG	3.10kW	2.40kW	85.1%	C#
⊗ 615-258	Matt Black	Tracery	-	Electric	-	2.00kW	-	-
⊗ 615-371	Ivory	Tracery	-	Electric	-	2.00kW	-	-
⊗ 615-624	Matt Ivory	Tracery	-	Electric	-	2.00kW	-	-

Gas & Electric Huntingdon 20 Clear Door

⊗ 515-071	Matt Black	Clear	Conventional	Nat Gas	3.30kW	2.30kW	76%	E
⊗ 515-441	Matt Black	Clear	Conventional	LPG	3.20kW	2.20kW	76%	E
⊗ 515-080	Ivory	Clear	Conventional	Nat Gas	3.30kW	2.30kW	76%	E
⊗ 515-468	Ivory	Clear	Conventional	LPG	3.20kW	2.20kW	76%	E
⊗ 515-089	Matt Ivory	Clear	Conventional	Nat Gas	3.30kW	2.30kW	76%	E
⊗ 515-477	Matt Ivory	Clear	Conventional	LPG	3.20kW	2.20kW	76%	E
⊗ 515-125	Matt Black	Clear	Balanced	Nat Gas	3.20kW	2.50kW	85.1%	C#
⊗ 515-529	Matt Black	Clear	Balanced	LPG	3.10kW	2.40kW	85.1%	C#
⊗ 515-134	Ivory	Clear	Balanced	Nat Gas	3.20kW	2.50kW	85.1%	C#
⊗ 515-545	Ivory	Clear	Balanced	LPG	3.10kW	2.40kW	85.1%	C#
⊗ 515-143	Matt Ivory	Clear	Balanced	Nat Gas	3.20kW	2.50kW	85.1%	C#
⊗ 515-556	Matt Ivory	Clear	Balanced	LPG	3.10kW	2.40kW	85.1%	C#
⊗ 615-011	Matt Black	Clear	-	Electric	-	2.00kW	-	-
⊗ 615-037	Ivory	Clear	-	Electric	-	2.00kW	-	-
⊗ 615-050	Matt Ivory	Clear	-	Electric	-	2.00kW	-	-

When upgraded with a Programmable Thermostatic Control (8456)

Technical Information

The below information is to assist in your choice of a suitable Gazco stove. This is not intended to be all the information required to install your stove. This can be obtained from your local Gazco retailer or you can download the full installation instructions at www.gazco.com

Huntingdon 30 Gas and Electric

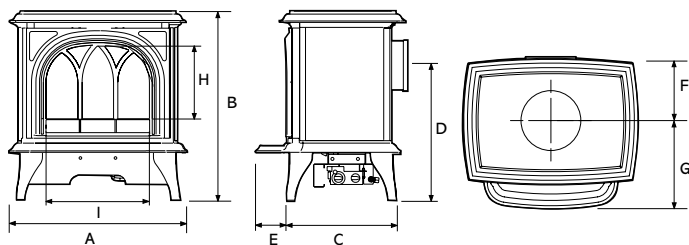

Recommended clearances between stove and other surfaces: top 9" (225mm), sides 6" (150mm), rear must be a minimum of 2" (50mm). The Huntingdon 30 has a choice of top or rear flue exit

Dimensions (mm)

	A	B	C	D	E	F	G	H	I	Weight
Huntingdon 30 Gas (CF)	560	592	351	403	96	174	304	230	323	72kg
Huntingdon 30 Gas (BF)	560	592	351	422	96	195	278	230	323	72kg
Huntingdon 30 Electric	560	592	351	-	99	-	-	230	323	52kg

Remote Controls

Product Code

Standard Upgradeable Remote Control	8455
Programmable Thermostatic Upgradeable Remote Control	8456

Stove Flue Pipe and Collars

1' Straight pipe, Matt Black	4500
2' Straight pipe, Matt Black	4501
3' Straight pipe, Matt Black	4502
90° long 'elbow' adaptor (9" projection), Matt Black	4514
1' Straight pipe, Ivory	4500IV
2' Straight pipe, Ivory	4501IV
3' Straight pipe, Ivory	4502IV
1' Straight pipe, Matt Ivory	4500PI
2' Straight pipe, Matt Ivory	4501PI
3' Straight pipe, Matt Ivory	4502PI
Matt Black Flue collar, Conventional Flue, Huntingdon	999-010
Matt Black Flue collar, Balanced Flue, Huntingdon	999-347
Ivory Enamel Flue collar, Conventional Flue, Huntingdon	999-266
Ivory Enamel Flue collar, Balanced Flue, Huntingdon	999-507
Matt Ivory Flue collar, Conventional Flue, Huntingdon	999-456
Matt Ivory Flue collar, Balanced Flue, Huntingdon	999-683

Stove Flue Pipe Balanced flue versions of the Gas Huntingdon 30 must only use the 6" stainless steel flue provided. For additional Matt Black, Matt Ivory and Ivory enamelled flue collars, please see the Gazco Stoves price list. Gazco recommends the use of 5" Matt Black enamelled stove pipe with the conventional flue version.

Gas & Electric Huntingdon 30 Tracery Door

Product Code	Colour	Door Style	Flue Type	Fuel Type	Heat Input	Heat Output	Efficiency	Energy Efficiency Class
⊗ 515-004	Matt Black	Tracery	Conventional	Nat Gas	4.55kW	3.10kW	75%	E
⊗ 515-413	Matt Black	Tracery	Conventional	LPG	4.35kW	3.00kW	75%	E
⊗ 515-154	Ivory	Tracery	Conventional	Nat Gas	4.55kW	3.10kW	75%	E
⊗ 515-484	Ivory	Tracery	Conventional	LPG	4.35kW	3.00kW	75%	E
⊗ 515-212	Matt Ivory	Tracery	Conventional	Nat Gas	4.55kW	3.10kW	75%	E
⊗ 515-536	Matt Ivory	Tracery	Conventional	LPG	4.35kW	3.00kW	75%	E
⊗ 515-257	Matt Black	Tracery	Balanced	Nat Gas	4.30kW	3.70kW	95.4%	A#
⊗ 515-561	Matt Black	Tracery	Balanced	LPG	4.30kW	3.80kW	95.4%	A#
⊗ 515-395	Ivory	Tracery	Balanced	Nat Gas	4.30kW	3.70kW	95.4%	A#
⊗ 515-664	Ivory	Tracery	Balanced	LPG	4.30kW	3.80kW	95.4%	A#
⊗ 515-333	Matt Ivory	Tracery	Balanced	Nat Gas	4.30kW	3.70kW	95.4%	A#
⊗ 515-712	Matt Ivory	Tracery	Balanced	LPG	4.30kW	3.80kW	95.4%	A#
⊗ 615-285	Matt Black	Tracery	-	Electric	-	2.00kW	-	-
⊗ 615-427	Ivory	Tracery	-	Electric	-	2.00kW	-	-
⊗ 615-643	Matt Ivory	Tracery	-	Electric	-	2.00kW	-	-

Gas & Electric Huntingdon 30 Clear Door

⊗ 515-009	Matt Black	Clear	Conventional	Nat Gas	4.55kW	3.10kW	75%	E
⊗ 515-453	Matt Black	Clear	Conventional	LPG	4.35kW	3.00kW	75%	E
⊗ 515-061	Ivory	Clear	Conventional	Nat Gas	4.55kW	3.10kW	75%	E
⊗ 515-505	Ivory	Clear	Conventional	LPG	4.35kW	3.00kW	75%	E
⊗ 515-100	Matt Ivory	Clear	Conventional	Nat Gas	4.55kW	3.10kW	75%	E
⊗ 515-570	Matt Ivory	Clear	Conventional	LPG	4.35kW	3.00kW	75%	E
⊗ 515-139	Matt Black	Clear	Balanced	Nat Gas	4.30kW	3.70kW	95.4%	A#
⊗ 515-726	Matt Black	Clear	Balanced	LPG	4.30kW	3.80kW	95.4%	A#
⊗ 515-165	Ivory	Clear	Balanced	Nat Gas	4.30kW	3.70kW	95.4%	A#
⊗ 515-739	Ivory	Clear	Balanced	LPG	4.30kW	3.80kW	95.4%	A#
⊗ 515-191	Matt Ivory	Clear	Balanced	Nat Gas	4.30kW	3.70kW	95.4%	A#
⊗ 515-765	Matt Ivory	Clear	Balanced	LPG	4.30kW	3.80kW	95.4%	A#
⊗ 615-094	Matt Black	Clear	-	Electric	-	2.00kW	-	-
⊗ 615-142	Ivory	Clear	-	Electric	-	2.00kW	-	-
⊗ 615-183	Matt Ivory	Clear	-	Electric	-	2.00kW	-	-

When upgraded with a Programmable Thermostatic Control (8456)

Technical Information

The below information is to assist in your choice of a suitable Gazco stove. This is not intended to be all the information required to install your stove. This can be obtained from your local Gazco retailer or you can download the full installation instructions at www.gazco.com

Huntingdon 40 Gas and Electric

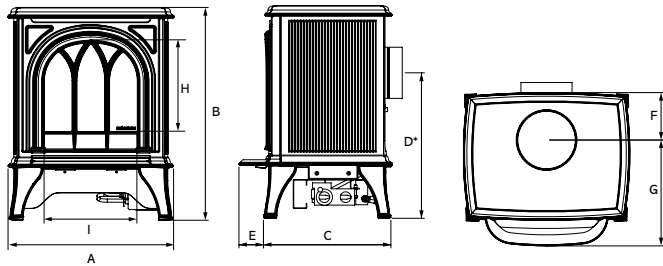

Recommended clearances between stove and other surfaces: top 9" (225mm), sides 6" (150mm), rear must be a minimum of 2" (50mm).

*Huntingdon 20 Balanced Flue is Rear Exit only.

Dimensions (mm)

	A	B	C	D	E	F	G	H	I	Weight
Huntingdon 40 Gas (CF)	641	653	382	460	99	154	350	265	402	71kg
Huntingdon 40 Gas (BF)	641	653	382	510	99	183	321	265	402	75kg
Huntingdon 40 Electric	641	653	397	-	99	-	-	265	402	59.5kg

Remote Controls for Gas Huntingdon 40

Product Code

Standard Upgradeable Remote Control	8455
Programmable Thermostatic Upgradeable Remote Control	8456

Stove Flue Pipe and Collars

1' Straight pipe, Matt Black	4500
2' Straight pipe, Matt Black	4501
3' Straight pipe, Matt Black	4502
90° long 'elbow' adaptor (9" projection), Matt Black	4514
1' Straight pipe, Ivory	4500IV
2' Straight pipe, Ivory	4501IV
3' Straight pipe, Ivory	4502IV
1' Straight pipe, Matt Ivory	4500PI
2' Straight pipe, Matt Ivory	4501PI
3' Straight pipe, Matt Ivory	4502PI
Matt Black Flue collar, Conventional Flue, Huntingdon	999-010
Matt Black Flue collar, Balanced Flue, Huntingdon	999-347
Ivory Enamel Flue collar, Conventional Flue, Huntingdon	999-266
Ivory Enamel Flue collar, Balanced Flue, Huntingdon	999-507
Matt Ivory Flue collar, Conventional Flue, Huntingdon	999-456
Matt Ivory Flue collar, Balanced Flue, Huntingdon	999-683

Stove Flue Pipe Balanced flue versions of the Gas Huntingdon 40 must only use the 6" stainless steel flue provided. For additional Matt Black, Matt Ivory and Ivory enamelled flue collars, please see the Gazco Stoves price list. Gazco recommends the use of 5" Matt Black enamelled stove pipe with the conventional flue version.

Gas & Electric Huntingdon 40 Tracery Door

Product Code	Colour	Door Style	Flue Type	Fuel Type	Heat Input	Heat Output	Efficiency	Energy Efficiency Class
⊗ 515-161	Matt Black	Tracery	Conventional	Nat Gas	6.60kW	4.60kW	78%	E
⊗ 515-565	Matt Black	Tracery	Conventional	LPG	6.70kW	4.80kW	78%	E
⊗ 515-170	Ivory	Tracery	Conventional	Nat Gas	6.60kW	4.60kW	78%	E
⊗ 515-574	Ivory	Tracery	Conventional	LPG	6.70kW	4.80kW	78%	E
⊗ 515-179	Matt Ivory	Tracery	Conventional	Nat Gas	6.60kW	4.60kW	78%	E
⊗ 515-583	Matt Ivory	Tracery	Conventional	LPG	6.70kW	4.80kW	78%	E
⊗ 515-224	Matt Black	Tracery	Balanced	Nat Gas	6.60kW	5.40kW	90.8%	B#
⊗ 515-628	Matt Black	Tracery	Balanced	LPG	6.60kW	5.50kW	90.8%	B#
⊗ 515-233	Ivory	Tracery	Balanced	Nat Gas	6.60kW	5.40kW	90.8%	B#
⊗ 515-646	Ivory	Tracery	Balanced	LPG	6.60kW	5.50kW	90.8%	B#
⊗ 515-242	Matt Ivory	Tracery	Balanced	Nat Gas	6.60kW	5.40kW	90.8%	B#
⊗ 515-655	Matt Ivory	Tracery	Balanced	LPG	6.60kW	5.50kW	90.8%	B#
⊗ 615-302	Matt Black	Tracery	-	Electric	-	2.00kW	-	-
⊗ 615-613	Ivory	Tracery	-	Electric	-	2.00kW	-	-
⊗ 615-662	Matt Ivory	Tracery	-	Electric	-	2.00kW	-	-

Gas & Electric Huntingdon 40 Clear Door

⊗ 515-188	Matt Black	Clear	Conventional	Nat Gas	6.60kW	4.60kW	78%	E
⊗ 515-592	Matt Black	Clear	Conventional	LPG	6.70kW	4.80kW	78%	E
⊗ 515-197	Ivory	Clear	Conventional	Nat Gas	6.60kW	4.60kW	78%	E
⊗ 515-601	Ivory	Clear	Conventional	LPG	6.70kW	4.80kW	78%	E
⊗ 515-206	Matt Ivory	Clear	Conventional	Nat Gas	6.60kW	4.60kW	78%	E
⊗ 515-619	Matt Ivory	Clear	Conventional	LPG	6.70kW	4.80kW	78%	E
⊗ 515-251	Matt Black	Clear	Balanced	Nat Gas	6.60kW	5.40kW	90.8%	B#
⊗ 515-673	Matt Black	Clear	Balanced	LPG	6.60kW	5.50kW	90.8%	B#
⊗ 515-269	Ivory	Clear	Balanced	Nat Gas	6.60kW	5.40kW	90.8%	B#
⊗ 515-682	Ivory	Clear	Balanced	LPG	6.60kW	5.50kW	90.8%	B#
⊗ 515-278	Matt Ivory	Clear	Balanced	Nat Gas	6.60kW	5.40kW	90.8%	B#
⊗ 515-691	Matt Ivory	Clear	Balanced	LPG	6.60kW	5.50kW	90.8%	B#
⊗ 615-123	Matt Black	Clear	-	Electric	-	2.00kW	-	-
⊗ 615-157	Ivory	Clear	-	Electric	-	2.00kW	-	-
⊗ 615-222	Matt Ivory	Clear	-	Electric	-	2.00kW	-	-

When upgraded with a Programmable Thermostatic Control (8456)

Technical Information

The below information is to assist in your choice of a suitable Gazco stove. This is not intended to be all the information required to install your stove. This can be obtained from your local Gazco retailer or you can download the full installation instructions at www.gazco.com

Vogue Gas and Electric

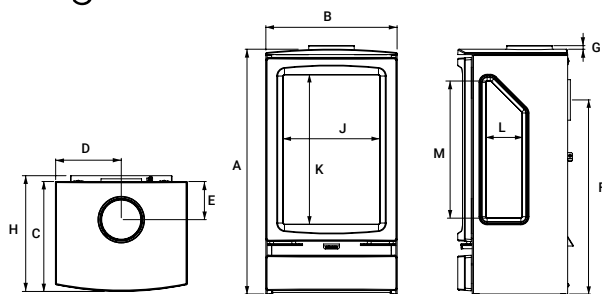

Recommended clearances between stove and other surfaces: top 225mm, sides 150mm rear must be a minimum of 50mm.

The complete range of Gas Vogue stoves have a choice of top or rear flue exit.

Stove Benches Vogue stoves can also be placed on one of our stove benches. Please see page 62 for further information.

Vogue Midi Gas & Electric Dimensions (mm)

	A	B	C	D	E	F	G	H	J	K	L	M	Weight
Vogue Gas Midi (CF)	639	416	348	208	121	478	11	-	306	337	-	-	42kg
Vogue Gas Midi (BF)	639	416	348	208	137	470	11	-	306	337	-	-	40kg
Vogue Gas Midi Midline (CF)	791	416	348	208	121	630	11	-	306	337	-	-	47kg
Vogue Gas Midi Midline (BF)	791	416	348	208	137	622	11	-	306	337	-	-	47kg
Vogue Electric Midi	639	416	348	-	-	-	-	-	306	337	-	-	42kg
Vogue Electric Midi Midline	791	416	348	-	-	-	-	-	306	337	-	-	48kg

Vogue Midi T Gas & Electric Dimensions (mm)

	A	B	C	D	E	F	G	H	J	K	L	M	Weight
Vogue Gas Midi T (CF)	776	416	348	208	121	615	11	367	306	475	115	434	54kg
Vogue Gas Midi T (BF)	776	416	348	209	137	607	11	-	306	475	115	434	55kg
Vogue Gas Midi T Midline (CF)	928	416	348	208	121	767	11	367	306	475	115	434	61kg
Vogue Gas Midi T Midline (BF)	928	416	348	209	137	759	11	-	306	475	115	434	62kg
Vogue Gas Midi T Highline (CF)	1260	416	348	208	121	1099	11	367	306	475	115	434	82kg
Vogue Gas Midi T Highline (BF)	1260	416	348	209	137	1091	11	-	306	475	115	434	83kg
Vogue Gas Midi T Wall Mounted (BF)	776	416	348*	209	137	-	11	-	306	475	115	434	62kg
Vogue Electric Midi T	776	418	349	-	-	-	-	-	306	475	115	434	38kg
Vogue Electric Midi T Midline	928	418	349	-	-	-	-	-	306	475	115	434	44kg
Vogue Electric Midi T Highline	1260	418	349	-	-	-	-	-	306	475	115	434	65kg
Vogue Electric Midi T Wall Mounted	776	416	348*	-	-	-	-	-	306	475	115	434	44kg

*360mm Depth when fitted with wall bracket

Options for Gas Vogue

	Product Code
Standard Upgradeable Remote Control	8455
Programmable Thermostatic Upgradeable Remote Control	8456
Vogue Midi T Highline (BF) Rear Vanity Cover Kit	963-175
Linerless Flue Kit	8736

Vogue Midi Gas & Electric

Product Code	Model	Flue Type	Fuel Type	Heat Input	Heat Output	Efficiency	Energy Efficiency Class
563-123	Midi	Conventional	Nat.Gas	6.20kW	4.20kW	76%	E
563-426	Midi	Conventional	LPG	6.20kW	4.30kW	76%	E
563-016	Midi	Balanced	Nat.Gas	4.80kW	3.90kW	90.6%	B#
563-400	Midi	Balanced	LPG	4.80kW	4.00kW	90.6%	B#
563-392	Midi Midline	Conventional	Nat.Gas	6.20kW	4.20kW	76%	E
563-466	Midi Midline	Conventional	LPG	6.20kW	4.30kW	76%	E
563-258	Midi Midline	Balanced	Nat.Gas	4.80kW	3.90kW	90.6%	B#
563-790	Midi Midline	Balanced	LPG	4.80kW	4.00kW	90.6%	B#
663-806	Midi Electric	-	Electric	-	1.50kW	-	-
663-834	Midi Midline Electric	-	Electric	-	1.50kW	-	-

Vogue Midi T Gas & Electric (3 Sided)

563-180	Midi T, 3 Sided	Conventional	Nat.Gas	6.20kW	4.40kW	78%	E
563-701	Midi T, 3 Sided	Conventional	LPG	5.90kW	4.20kW	78%	E
563-025	Midi T, 3 Sided	Balanced	Nat.Gas	5.70kW	4.80kW	94.3%	A#
563-749	Midi T, 3 Sided	Balanced	LPG	5.00kW	4.30kW	94.3%	A#
563-224	Midi T Midline, 3 Sided	Conventional	Nat.Gas	6.20kW	4.40kW	78%	E
563-493	Midi T Midline, 3 Sided	Conventional	LPG	5.90kW	4.20kW	78%	E
563-300	Midi T Midline, 3 Sided	Balanced	Nat.Gas	5.70kW	4.80kW	94.3%	A#
563-676	Midi T Midline, 3 Sided	Balanced	LPG	5.00kW	4.30kW	94.3%	A#
563-191	Midi T Highline, 3 Sided	Conventional	Nat.Gas	6.20kW	4.40kW	78%	E
563-447	Midi T Highline, 3 Sided	Conventional	LPG	5.90kW	4.20kW	78%	E
563-216	Midi T Highline, 3 Sided	Balanced	Nat.Gas	5.70kW	4.80kW	94.3%	A#
563-458	Midi T Highline, 3 Sided	Balanced	LPG	5.00kW	4.30kW	94.3%	A#
563-013	Midi T, 3 Sided, Wall Mounted	Balanced	Nat.Gas	5.70kW	4.80kW	94.3%	A#
563-506	Midi T, 3 Sided, Wall Mounted	Balanced	LPG	5.00kW	4.30kW	94.3%	A#
663-819	Midi T Electric, 3 Sided	-	Electric	-	1.50kW	-	-
663-851	Midi T Midline Electric, 3 Sided	-	Electric	-	1.50kW	-	-
663-896	Midi T Highline Electric, 3 Sided	-	Electric	-	1.50kW	-	-
663-860	Midi T Electric, Wall Mounted, 3 Sided	-	Electric	-	1.50kW	-	-

When upgraded with a Programmable Thermostatic Control (8456)

Stove Flue Pipe

	Product Code
1' Straight pipe, Matt Black	4500
2' Straight pipe, Matt Black	4501
3' Straight pipe, Matt Black	4502
90° long 'elbow' adaptor (9" projection), Matt Black	4514

Stove Flue Pipe Balanced flue versions of the Gas Vogue Midi and Midi T must only use the 6" stainless steel flue provided. Gazco recommends the use of 5" matt black enamelled stove pipe with the conventional flue version of the Gas Vogue Midi and Midi T.

Technical Information

The below information is to assist in your choice of a suitable Gazco stove. This is not intended to be all the information required to install your stove. This can be obtained from your local Gazco retailer or you can download the full installation instructions at www.gazco.com

Loft Gas

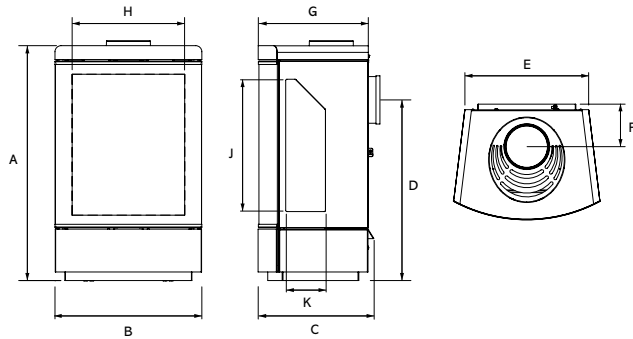

Recommended clearances between stove and other surfaces: top 225mm, sides 200mm, rear must be a minimum of 50mm.

Dimensions (mm)	A	B	C	D	E	F	G	H	J	K
Loft	770	481	379	CF:600 / BF:592	406	CF:139 / BF:137	359	369	434	130
Loft with Plinth	815	481	379	CF:646 / BF:638	406	CF:139 / BF:137	359	369	434	130
Loft with Top Section	1412	481	379	CF:600 / BF:592	406	CF:139 / BF:137	359	369	434	130
Loft with Plinth & Top Section	1457	481	379	CF:646 / BF:638	406	CF:139 / BF:137	359	369	434	130
Loft with Log Store	1152	481	379	CF:982 / BF:974	406	CF:139 / BF:137	359	369	434	130
Loft with Log Store & Top Section	1793	481	379	CF:982 / BF:974	406	CF:139 / BF:137	359	369	434	130
Loft Wall Mounted	770	481	399	BF:592	406	BF:137	359	369	434	130
Loft Wall Mounted & Top Section	1412	480	399	BF:592	406	BF:137	359	369	434	130

Product Code	Flue Type	Fuel Type	Heat Input	Heat Output	Efficiency	Energy Efficiency Class	Weight
⊗ 548-006	Conventional	Nat.Gas	6.20kW	4.40kW	78%	D	56kg
⊗ 548-443	Conventional	LPG	5.90kW	4.20kW	78%	D	56kg
⊗ 548-032	Balanced	Nat.Gas	5.30kW	4.50kW	94.3%	A	60kg
⊗ 548-457	Balanced	LPG	4.80kW	4.20kW	94.3%	A	60kg

Styling Options

948-191	Loft - Wall Mounting Kit
948-016	Loft Plinth - Steel Graphite
948-030	Loft Log Store - Steel Graphite
948-041	Loft Top Section - Steel Graphite
948-077	Loft Plinth - Woodgrain Sandstone
948-102	Loft Plinth - Castillo Sandstone
948-083	Loft Log Store - Woodgrain Sandstone
948-110	Loft Log Store - Castillo Sandstone

Stove Benches Loft stoves can also be placed on one of our stove benches. Please see page 62 for further information.

Accessories

999-620	Remote System Mains Adaptor
8736	Linerless Flue Kit

Stove Flue Pipe

4500	1' Straight pipe
4501	2' Straight pipe
4502	3' Straight pipe
4514	90° Long 'elbow' adaptor (9° projection)

Stove Flue Pipe Balanced flue versions of the Loft must only use the 6" stainless steel flue provided. Gazco recommends the use of 5" matt black enameled stove pipe with the conventional flue version of the Loft.



Loft with Steel Log Store Base

Technical Information

The below information is to assist in your choice of a suitable Gazco stove. This is not intended to be all the information required to install your stove. This can be obtained from your local Gazco retailer or you can download the full installation instructions at www.gazco.com

Vision Gas and Electric

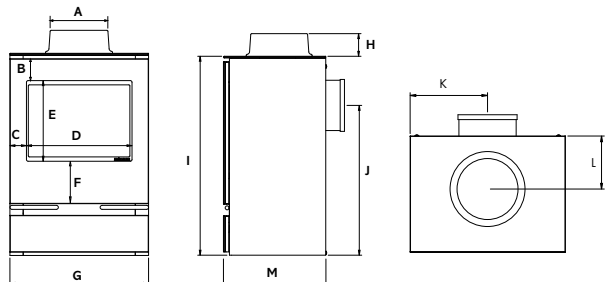

Recommended clearances between stove and other surfaces: top 225mm, sides 150mm and rear 50mm.

Stove Benches Vision stoves can also be placed on one of our stove benches. Please see page 62 for further information.

* Small balanced flue models are rear flue exit only

Dimensions (mm)

	A	B	C	D	E	F	G	H	I	J	K	L	M	Weight
Small Gas (CF)	143	57	58	254	240	122	370	43	529	359	185	97	289	33kg
Small Gas (BF)*	-	57	58	254	240	122	370	-	529	379	185	-	289	33kg
Midi Gas (CF)	143	65	50	316	241	127	415	43	605	436	208	96	311	39kg
Midi Gas (BF)	173	65	50	316	241	127	415	69	605	456	208	142	311	41kg
Medium Gas (CF)	143	77	64	408	274	150	535	43	677	487	268	100	353	45kg
Medium Gas (BF)	173	77	64	408	274	150	535	69	677	538	268	139	353	55kg
Small Electric	-	57	58	254	240	122	370	-	555	-	-	-	299	24kg
Midi Electric	-	65	50	316	241	127	415	-	604	-	-	-	320	28kg
Medium Electric	-	77	64	408	274	152	535	-	676	-	-	-	363	38kg

Remote Controls

	Product Code
Standard Upgradeable Remote Control	8455
Programmable Thermostatic Upgradeable Remote Control	8456

Stove Flue Pipe

1' Straight pipe, Matt Black	4500
2' Straight pipe, Matt Black	4501
3' Straight pipe, Matt Black	4502
90° long 'elbow' adaptor (9" projection), Matt Black	4514

Stove Flue Pipe Balanced flue versions of the Gas Visions must only use the 6" stainless steel or anthracite flue pipe. For the conventional flue version of the Gas Vision Gazco recommends the use of 5" matt black or gloss enamelled stove pipe.

Product Code	Model	Flue Type	Fuel Type	Flue Exit	Heat Input (kW)	Heat Output (kW)	Efficiency	Energy Efficiency Class
⊗ 526-013	Small	Conventional	Nat. Gas	Rear	3.30	2.30	76%	E
⊗ 526-643	Small	Conventional	LPG	Rear	3.20	2.20	76%	E
⊗ 526-021	Small	Conventional	Nat Gas	Top	3.30	2.30	76%	E
⊗ 526-656	Small	Conventional	LPG	Top	3.20	2.20	76%	E
⊗ 526-046	Small	Balanced	Nat. Gas	Rear	3.20	2.50	85.1%	C#
⊗ 526-405	Small	Balanced	LPG	Rear	3.10	2.40	85.1%	C#

Gas Vision Midi

⊗ 526-065	Midi	Conventional	Nat.Gas	Rear	4.55	3.10	75%	E
⊗ 526-417	Midi	Conventional	LPG	Rear	4.35	3.00	75%	E
⊗ 526-077	Midi	Conventional	Nat.Gas	Top	4.55	3.10	75%	E
⊗ 526-440	Midi	Conventional	LPG	Top	4.35	3.00	75%	E
⊗ 526-100	Midi	Balanced	Nat. Gas	Rear	4.30	3.70	95.4%	A#
⊗ 526-471	Midi	Balanced	LPG	Rear	4.30	3.80	95.4%	A#
⊗ 526-109	Midi	Balanced	Nat. Gas	Top	4.30	3.70	95.4%	A#
⊗ 526-486	Midi	Balanced	LPG	Top	4.30	3.80	95.4%	A#

Gas Vision Medium

⊗ 526-122	Medium	Conventional	Nat.Gas	Rear	6.60	4.60	78%	E
⊗ 526-515	Medium	Conventional	LPG	Rear	6.70	4.80	78%	E
⊗ 526-137	Medium	Conventional	Nat.Gas	Top	6.60	4.60	78%	E
⊗ 526-539	Medium	Conventional	LPG	Top	6.70	4.80	78%	E
⊗ 526-155	Medium	Balanced	Nat. Gas	Rear	6.60	5.40	90.8%	B#
⊗ 526-580	Medium	Balanced	LPG	Rear	6.60	5.50	90.8%	B#
⊗ 526-176	Medium	Balanced	Nat Gas	Top	6.60	5.40	90.8%	B#
⊗ 526-612	Medium	Balanced	LPG	Top	6.60	5.50	90.8%	B#

Electric Vision

⊗ 634-808	Small	-	Electric	-	-	1.50	-	-
⊗ 634-846	Midi	-	Electric	-	-	1.50	-	-
⊗ 634-889	Medium	-	Electric	-	-	1.50	-	-

When upgraded with a Programmable Thermostatic Control (8456)

Technical Information

The below information is to assist in your choice of a suitable Gazco stove. This is not intended to be all the information required to install your stove. This can be obtained from your local Gazco retailer or you can download the full installation instructions at www.gazco.com

Studio Freestanding 1 Gas

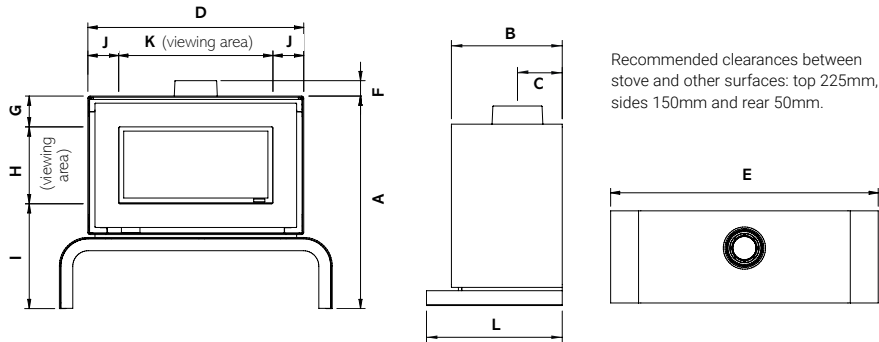

Dimensions (mm)	A	B	C	D	E	F	G	H	I	J	K	L	Weight
Studio 1 Freestanding on Bench	896	396	CF: 148 BF: 160	910	1150	CF: 43 BF: 65	130	324	442	130	650	-	146kg
Studio 1 Freestanding on Plinth	649	396	CF: 148 BF: 160	910	1105	CF: 43 BF: 65	130	324	195	130	650	485	141.5kg



Product Code	Finish	Flue Type	Fuel Effect	Lining	Fuel Type	Heat Input (kW)	Heat Output (kW)	Efficiency	Energy Efficiency Class
508-147	Black	Conventional	Logs	Black Glass	Nat. Gas	6.30	4.10	72%	E
508-589	Black	Conventional	Logs	Black Glass	LPG	6.90	4.60	72%	E
508-199	White	Conventional	Logs	Black Glass	Nat. Gas	6.30	4.10	72%	E
508-606	White	Conventional	Logs	Black Glass	LPG	6.90	4.60	72%	E
508-248	Black	Balanced	Logs	Black Glass	Nat. Gas	6.30	5.20	92%	A
508-597	Black	Balanced	Logs	Black Glass	LPG	6.30	5.30	92%	A
508-151	White	Balanced	Logs	Black Glass	Nat. Gas	6.30	5.20	92%	A
508-488	White	Balanced	Logs	Black Glass	LPG	6.30	5.30	92%	A

Studio 1 Freestanding - Pebble & Stone Effect

508-077	Black	Conventional	Peb & Stone	Black Glass	Nat. Gas	6.30	4.10	72%	E
508-517	Black	Conventional	Peb & Stone	Black Glass	LPG	6.90	4.60	72%	E
508-366	White	Conventional	Peb & Stone	Black Glass	Nat. Gas	6.30	4.10	72%	E
508-615	White	Conventional	Peb & Stone	Black Glass	LPG	6.90	4.60	72%	E
508-396	Black	Balanced	Peb & Stone	Black Glass	Nat. Gas	6.30	5.20	92%	A
508-699	Black	Balanced	Peb & Stone	Black Glass	LPG	6.30	5.30	92%	A
508-175	White	Balanced	Peb & Stone	Black Glass	Nat. Gas	6.30	5.20	92%	A
508-510	White	Balanced	Peb & Stone	Black Glass	LPG	6.30	5.30	92%	A

Studio 1 Freestanding - Driftwood Effect

508-045	Black	Conventional	Driftwood	Black Glass	Nat. Gas	6.30	4.10	72%	E
508-440	Black	Conventional	Driftwood	Black Glass	LPG	6.90	4.60	72%	E
508-066	White	Conventional	Driftwood	Black Glass	Nat. Gas	6.30	4.10	72%	E
508-479	White	Conventional	Driftwood	Black Glass	LPG	6.90	4.60	72%	E
508-057	Black	Balanced	Driftwood	Black Glass	Nat. Gas	6.30	5.20	92%	A
508-465	Black	Balanced	Driftwood	Black Glass	LPG	6.30	5.30	92%	A
508-117	White	Balanced	Driftwood	Black Glass	Nat. Gas	6.30	5.20	92%	A
508-502	White	Balanced	Driftwood	Black Glass	LPG	6.30	5.30	92%	A

Plinth & Bench Mounting Choice (Required)

999-022	Studio 1 Freestanding Plinth - Black
999-035	Studio 1 Freestanding Plinth - White
999-101	Studio 1 Freestanding Bench - Black
999-114	Studio 1 Freestanding Bench - White

Additional Lining Sets

923-010	Studio 1 CF - Vermiculite Lining Set
923-517	Studio 1 CF - Black Reeded Lining Set
923-433	Studio 1 BF - Vermiculite Lining Set
923-607	Studio 1 BF - Black Reeded Lining Set

Accessories

999-620	Remote System Mains Adaptor
---------	-----------------------------

Technical Information

The below information is to assist in your choice of a suitable Gazco stove. This is not intended to be all the information required to install your stove. This can be obtained from your local Gazco retailer or you can download the full installation instructions at www.gazco.com

Studio Freestanding 2 Gas

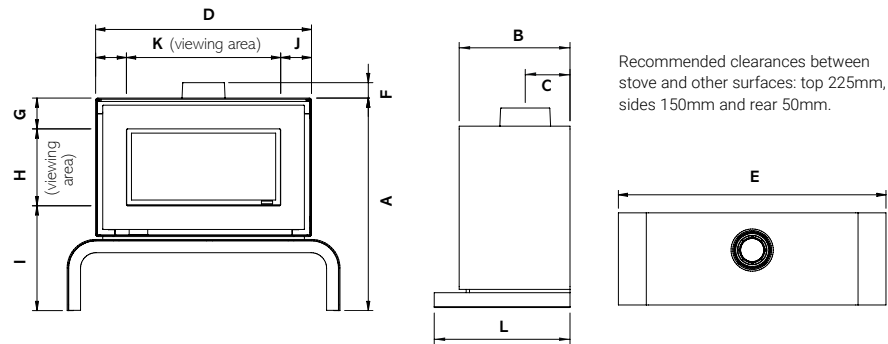

Dimensions (mm)	A	B	C	D	E	F	G	H	I	J	K	L	Weight
Studio 2 Freestanding on Bench	896	396	CF: 148 BF: 160	1110	1350	CF: 43 BF: 65	130	324	442	130	850	-	148kg
Studio 2 Freestanding on Plinth	649	396	CF: 148 BF: 160	1110	1305	CF: 43 BF: 65	130	324	195	130	850	485	143.5kg



Product Code	Finish	Flue Type	Fuel Effect	Lining	Fuel Type	Heat Input (kW)	Heat Output (kW)	Efficiency	Energy Efficiency Class
⊗ 508-094	Black	Conventional	Logs	Black Glass	Nat. Gas	8.50	6.20	81%	C
⊗ 508-426	Black	Conventional	Logs	Black Glass	LPG	8.40	6.30	82%	C
⊗ 508-187	White	Conventional	Logs	Black Glass	Nat. Gas	8.50	6.20	81%	C
⊗ 508-418	White	Conventional	Logs	Black Glass	LPG	8.40	6.30	82%	C
⊗ 508-027	Black	Balanced	Logs	Black Glass	Nat. Gas	8.50	7.00	92%	A
⊗ 508-444	Black	Balanced	Logs	Black Glass	LPG	8.00	6.80	92%	A
⊗ 508-102	White	Balanced	Logs	Black Glass	Nat. Gas	8.50	7.00	92%	A
⊗ 508-640	White	Balanced	Logs	Black Glass	LPG	8.00	6.80	92%	A

Studio 2 Freestanding - Pebble & Stone Effect

⊗ 508-207	Black	Conventional	Peb & Stone	Black Glass	Nat. Gas	8.50	6.20	81%	C
⊗ 508-651	Black	Conventional	Peb & Stone	Black Glass	LPG	8.40	6.30	82%	C
⊗ 508-282	White	Conventional	Peb & Stone	Black Glass	Nat. Gas	8.50	6.20	81%	C
⊗ 508-750	White	Conventional	Peb & Stone	Black Glass	LPG	8.40	6.30	82%	C
⊗ 508-033	Black	Balanced	Peb & Stone	Black Glass	Nat. Gas	8.50	7.00	92%	A
⊗ 508-527	Black	Balanced	Peb & Stone	Black Glass	LPG	8.00	6.80	92%	A
⊗ 508-322	White	Balanced	Peb & Stone	Black Glass	Nat. Gas	8.50	7.00	92%	A
⊗ 508-508	White	Balanced	Peb & Stone	Black Glass	LPG	8.00	6.80	92%	A

Studio 2 Freestanding - Driftwood Effect

⊗ 508-201	Black	Conventional	Driftwood	Black Glass	Nat. Gas	8.50	6.20	81%	C
⊗ 508-498	Black	Conventional	Driftwood	Black Glass	LPG	8.40	6.30	82%	C
⊗ 508-303	White	Conventional	Driftwood	Black Glass	Nat. Gas	8.50	6.20	81%	C
⊗ 508-581	White	Conventional	Driftwood	Black Glass	LPG	8.40	6.30	82%	C
⊗ 508-171	Black	Balanced	Driftwood	Black Glass	Nat. Gas	8.50	7.00	92%	A
⊗ 508-562	Black	Balanced	Driftwood	Black Glass	LPG	8.00	6.80	92%	A
⊗ 508-382	White	Balanced	Driftwood	Black Glass	Nat. Gas	8.50	7.00	92%	A
⊗ 508-655	White	Balanced	Driftwood	Black Glass	LPG	8.00	6.80	92%	A

Plinth & Bench Mounting Choice (Required)

999-048	Studio 2 Freestanding Plinth - Black
999-087	Studio 2 Freestanding Plinth - White
999-127	Studio 2 Freestanding Bench - Black
999-166	Studio 2 Freestanding Bench - White

Additional Lining Sets

923-337	Studio 2 CF - Vermiculite Lining Set
923-744	Studio 2 CF - Black Reeded Lining Set
923-938	Studio 2 BF - Vermiculite Lining Set
923-476	Studio 2 BF - Black Reeded Lining Set

Accessories

999-620	Remote System Mains Adaptor
---------	-----------------------------

Balanced Flue Gas Stove Systems

The Gazco Balanced Flue system means no chimney is not a problem if you opt for a balanced flue gas stove, as it draws combustion air from outside through its concentric pipe systems. A full range of optional flue components is available to suit configurations shown on page 64.

Gazco have specifically developed a range of flue system components to complement your balanced flue stove. Crafted from 304 grade stainless steel and aluminium with some items additionally offered in anthracite and matt ivory paint finishes. Designed with ease of installation and flexibility in mind, these flue systems simply push together without the requirement for locking bands or screws. Both the inner and outer pipes are secured with easy fit, self locking, high temperature silicone seals. For further information, please speak to your retailer or visit www.gazco.com.



Rear Exit Terminal

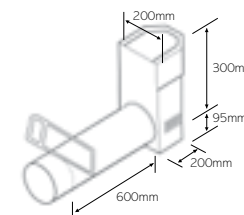

Up & Out Terminal

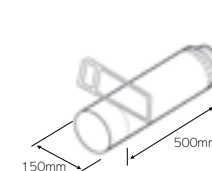

Vertical Terminal

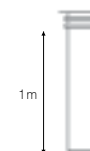

Components for Balanced Flue Models

Basic Stainless Steel Kits

Product Code	Description
8526	Rear exit, horizontal - complete with terminal guard
8523	Top exit, up & out for Sheraton 5, Huntingdon 30, Stockton 5, Loft, Vision Midi & all Vogues
8509	Top exit, up & out for Vision Medium
8524	Top exit, vertical for all Loft & Vogue Midi T
999-539	Top exit vertical for Sheraton 5, Huntingdon 30/40, Stockton 5, Vision & Vogue Midi
8530	45° offset bend (set of two) for use with 8524

Basic Anthracite Steel Kits*

Product Code	Description
8523AN	Top exit, up & out for Sheraton 5, Huntingdon 30, Stockton5, Loft, Vision Midi & all Vogues
8509AN	Top exit, up & out for Vision Medium
8524AN	Top exit, vertical for all Loft & Vogue Midi T
999-539AN	Top exit vertical for Sheraton 5, Huntingdon 30/40, Stockton 5, Vision & Vogue Midi
8530AN	45° offset bend (set of two) for use with 8524AN

Basic Matt Ivory Steel Kits*

Product Code	Description
999-111	Top exit, up & out for Huntingdon 30
999-224	Top exit vertical for Huntingdon 30/40

Additional Anthracite Steel components for top exit (as required)

8527AN	200mm straight (effective length 140mm)
8528AN	500mm straight (effective length 440mm)
8529AN	1000mm straight (effective length 940mm)
999-031	15° bend
999-078	30° bend
8507AN	45° bend
8508AN	90° bend

Additional Stainless Steel components for top exit (as required)

8527	200mm straight (effective length 140mm)
8528	500mm straight (effective length 440mm)
8529	1000mm straight (effective length 940mm)
999-062	364-554mm adjustable straight
999-003	15° bend
999-016	30° bend
8507	45° bend
8508	90° bend
999-105	Horizontal flue terminal (wall)
999-141	Vertical flue terminal (roof)
999-072	Fixed wall support
999-130	Adjustable wall support
999-235	External wall finishing plate

Additional Matt Ivory Steel components for top exit (as required)

999-357	200mm straight (effective length 140mm)
999-372	500mm straight (effective length 440mm)
999-391	1000mm straight (effective length 940mm)
999-051	15° bend
999-067	30° bend
999-172	45° bend
999-284	90° bend

Terminal Guards

999-159	Rear exit
999-201	Horizontal exit

*Note: Terminal lengths are stainless steel.

Please note the Small Balanced Flue models of Marlborough2, Stockton2, Huntingdon 20 and Vision Small are rear flue exit only.

The above information is to assist in your choice of a suitable Gazco stove. This is not intended to be all the information required to install your stove. This can be obtained from your local Gazco retailer or you can download the full installation instructions from the Gazco website at www.gazco.com.

Aquaseal Flashings

FXQ-052	125-175mm Aluminium Base EPDM Black to 115°C
FXQ-053	150-300mm Aluminium Base EPDM Black to 115°C
FXQ-054	150-200mm Lead Base EPDM Black to 115°C
FXQ-058	150-250mm Sq Section EPDM Black to 115°C
FXQ-059	150-250mm Sq Section/Metal EPDM Black to 115°C
FXQ-059SK	EPDM Flashing Fixing Kit

Lead Flashings

999-154	Flat Lead Flashing
999-161	30-40 Degree Lead Flashing
999-174	40-50 Degree Lead Flashing
999-182	45-50 Degree Lead Flashing
999-193	45-50 Degree Ridge Flashing

Additional Components

999-032	Roof Support Balanced Flue
999-040	Fire Stop Balanced Flue
999-046R	Storm Collar Balanced Flue
999-220	Rear Heat Shield Plate Kit to be used with 8526, if required

Additional Cast Iron Components for Top Exit

8548	Flue collar (BF), Matt Black
999-347	Flue collar (BF), Matt Black - Huntingdon 30 & 40 only
999-507	Flue collar (BF), Matt Ivory - Huntingdon 30 & 40 only
999-683	Flue collar (BF), Ivory Enamel - Huntingdon 30 & 40 only

Also Available from the Stovax Heating Group

Stovax Wood & Multi-fuel Stoves

Stovax, our solid fuel division, offer a huge range of beautiful stoves that burn wood and other solid fuels. Designed and engineered here in the UK, these appliances offer a natural and practical home heating solution.

Choose from a stunning range of modern and traditional styles in various sizes and heat outputs to suit your home. For more details speak with your local retailer or visit www.stovax.com.



Stovax Sheraton 5 woodburning stove shown with Cavendish Bolection Limestone mantel



Gazco eReflex 135R Inset Electric fire

Gazco Gas & Electric Fires

In addition to the wide selection of stoves shown in this brochure, Gazco also offers a number of gas and electric fires, which are covered in a separate dedicated brochures. Whether you want to achieve a contemporary look or traditional interior, Gazco has the perfect solution whatever your style or budget.

Ask your local retailer for more information or download the brochure from www.gazco.com.



Gazco Reflex 75T 3-Sided Gas fire



*Gas Huntingdon 30 with Tracery Door in Ivory Enamel.
Shown with Claremont Limestone Mantel*



*Vogue Midi T Midline Electric with Log &
Pebble Fuel effects and Amber flame setting*



Gazco Limited, Osprey Road, Sowton Industrial Estate, Exeter, Devon, England EX2 7JG

Tel: 01392 261999 • Fax: 01392 444148 • E-mail: info@gazco.com

www.gazco.com



Gazco gratefully acknowledges the assistance of the following companies with photographic settings:

www.furniturevillage.co.uk; www.romo.com; www.debenhams.com; www.theorangetree.co.uk; www.justshutters.co.uk; www.homebase.co.uk; www.lauraashley.com; www.loaf.com
www.nestinteriors.com; www.graceandgloryhome.co.uk; www.stbridgetnurseries.co.uk; www.johnlewis.com; www.wayfair.com; www.veryvintagehire.co.uk; www.carpetright.co.uk;
www.beachbros.co.uk; www.birlea.com; www.originalstyle.com; www.amtico.com; www.chunkymonkeyfurniture.co.uk; www.wallsandfloors.co.uk; www.desenio.co.uk; www.ikea.com;

Paper sourced from sustainable forests and printed using vegetable based inks • © All material copyright Gazco Ltd 2020 E & O E • A member of the Stovax group

Gazco pursue a policy of continuous product improvement, therefore, whilst our products are correct at the time of the photography, we reserve the right to make alterations and amendments. Exact product details should be discussed with your retailer at the time of purchase.

Find Your Local Expert Retailer

You can find your nearest retailer by visiting:
www.gazco.com/find-a-retailer



Your Gazco stockist:

£3.00

Ref: STOV0620

