

TIMELESS NORWEGIAN CRAFT



Since 1853



TIMELESS NORWEGIAN CRAFT

Jøtul wood stoves, fireplaces and inserts made of cast iron are hand-made at our factory in Norway. Since 1853, we have combined solid and beautiful craft with the art of fighting the cold. This is the background for our global position as market-leader and the preferred choice for demanding customers everywhere.



MARKET LEADER SINCE 1853 IN NORWAY

Norway is known all over the world for our attitude towards sustainability and the environment. We have the most stringent demands on emissions in the world.

This is why Jøtul always perfects the utilization of the wood and optimize the heating effect of our products. Our unique position is good news for your pockets and for the environment.



CAST IRON – SUPERIOR QUALITY

Choosing cast iron for our products is solely based on the extremely high quality and long durability of the material. Cast iron is a stable material that keeps its shape and does not bend the way steel plates do. A Jøtul wood stove keeps its shape. Doors, hinges and locking mechanisms remain intact even after many years of use.



AWARD-WINNING, TIMELESS DESIGN

The Jøtul product line represents a functional, modern design. It is innovative, yet can stand the test of time. At Jøtul, we are convinced that form follows function and that good design is more than what immediately meets the eye. As a testament to this, we are proud to say that several of our products have received recognised design awards.

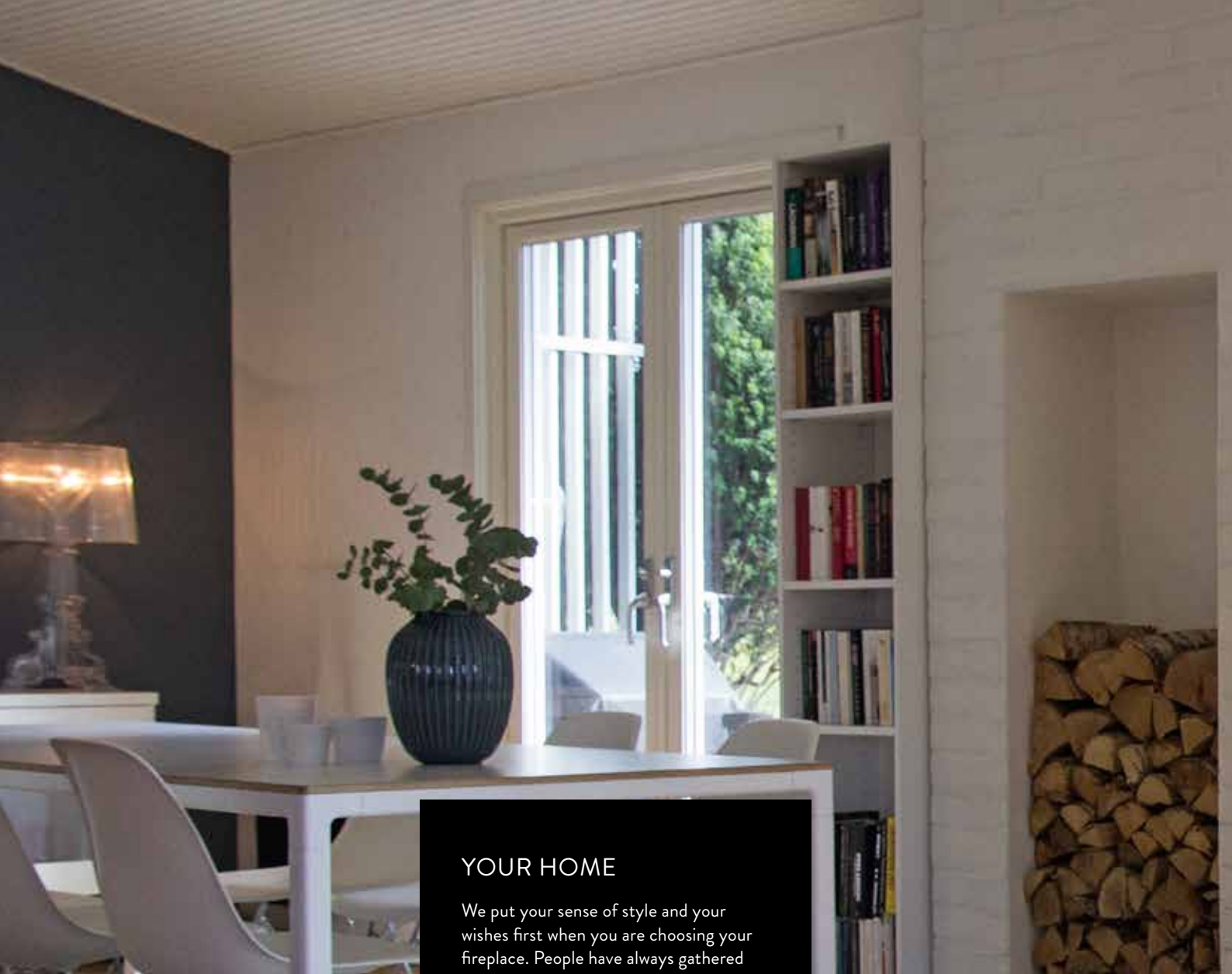

YOUR HOME

We put your sense of style and your wishes first when you are choosing your fireplace. People have always gathered around the fire, and we still do to this day. A new wood stove provides comfortable warmth and a real cozy feeling in the room – provided that it burns in the optimal way. Through generations, Jøtul has perfected the art of clean-burning wood stoves with clear glass and our fireplaces are easy to use.

SAFETY FIRST

Choosing a wood stove from Jøtul is a safe bet. Our wood stoves undergo thorough testing. You can rest assured that a fireplace from the world's leading supplier is of top notch quality. Imagine the joy and the benefits that a fireplace can bring on the really cold days during the winter season.



A JØTUL FIREPLACE IN NO TIME

Our goal is to make it easy for you to choose your new fireplace. Take a few pictures of where you want to install the fireplace and the area that the heat from the fireplace should cover. Bring this with you to one of our retailers and they will make sure to guide you to the right fireplace for your needs. Often, you can install our products yourself. However, Jøtul retailers often provide installation services as well. All that is left for you to do is enjoy the heat from the Jøtul fireplace.

PART OF HOMES SINCE 1853

We have more than 160 year of experience and we know what it takes for a wood-burning heating source to work. We continuously research new technology to make sure you get the best possible product. The only thing you need to do is choose the type of fireplace you like best.

Just make sure you choose a fireplace from Jøtul to guarantee your satisfaction.







JØTUL F 370 ADVANCE - NEW

ENHANCING AN ICONIC DESIGN

With the 370 Series, Jøtul redefined stove design and won the Red Dot; Best of the best. It quickly became Europe's most popular stove. With the F 370 Advance we do it again. The view of the fire is even greater and the easy to use air control ensures clean glass. Welcome to the future.

EXPLORE THE ENTIRE SELECTION ON PAGE 16.

JØTUL F 130-SERIES - NEW

MAXIMUM COMFORT

Jøtul F 130-series is a modern and stylish designed woodstove. For houses with a low energy demand, this stove is an ideal option. It is compact and designed to function optimally on low burn. This will in turn give you a positive heating experience both when it comes to warmth and a great view of the flames.

EXPLORE THE ENTIRE SELECTION ON PAGE 20.









JØTUL F 105 SERIES

WOOD STOVE WITH CHARACTER

In spite of its size the Jøtul F 105 is a wood stove that stands out from the rest and is adapted for low energy homes. Some of the distinctive design elements of this wood stove include the large horizontal glass door, which offers a great view to the fire and the intuitive air control that make it very user friendly. The wood stove is available on short legs or longer legs or on a base. An ash lip and soapstone top can be fitted as an optional accessory. EXPLORE THE ENTIRE SELECTION ON PAGE 22.



JØTUL F 520

A CAMPFIRE IN YOUR LIVING ROOM

With panoramic view to the fire, JØTUL F 520 offers the experience of a live campfire in your living room. This wood stove offers a wide expanse of glass panels, the flames can be fully enjoyed from three sides of the stove. All 3 glasses have a special heat reflecting surface ensuring cleaner glass and better combustion. The smart construction of the air valves makes the stove easy to light and is user friendly.

READ MORE ABOUT IT ON PAGE 27.





JØTUL F 305 SERIES

WATCH THE FLAMES

The philosophy behind Jøtul F 305 was to take an archetypal stove and perfect it down to the last detail. Our goal was to create a timeless wood stove with all the qualities of the traditional stoves pioneered by Jøtul. The result is an easy to use woodstove, focusing on functionality and heating capabilities, available in black paint or modern white enamel. Compared to traditional stoves, we have lifted the height of the burn chamber and the clean front design brings forward the flame from within.

Jøtul F 305 LL comes in black paint and white enamel. [EXPLORE THE ENTIRE SELECTION ON PAGE 23.](#)



AWARD FOR DESIGN EXCELLENCE
NORWEGIAN DESIGN COUNCIL



NOMINATED FOR
HONOURS AWARD FOR DESIGN EXCELLENCE



reddot award 2015
winner

DESIGN ICON

The Jøtul F 370 Advance has the worlds most celebrated stove design. The large fire view is easily kept clean by the easy-to-use air valve. Several different modules are available, all to meet your personal needs and taste



EFFICIENCY
78 %

LOG SIZE
33 CM

HEATING CAPACITY
55 - 130 M²

ECO CERTIFIED



JØTUL F 371 ADVANCE - NEW



The Jøtul F 371 Advance is characterised by a base in a sleek design, clean lines and a practical shelf for storage in its base.

EFFECT: min. 3.9 | max. 9.0 kW
FLUE EXIT OPTIONS: Top and rear,
Ø150 mm
WEIGHT APPROX.: 164 kg
DIMENSIONS, BASIC MODEL (HxWxD):
1155x443x453 mm

COLOURS:
● Black paint

ACCESSORIES: Cast iron door for base,
removable shelf in the base, glass or steel
floor plate, external air connection.

JØTUL F 373 ADVANCE - NEW



The Jøtul F 373 Advance is characterised by its modern design where the combustion chamber sits on a pedestal. This model is a re-design of the only wood stove in the world to have won the prestigious, international "Red dot design award: best of the best."

EFFECT: min. 3.9 | max. 9.0 kW
FLUE EXIT OPTIONS: Top and rear,
Ø150 mm
WEIGHT APPROX.: 156 kg
DIMENSIONS, BASIC MODEL (HxWxD):
1155x443x453 mm

COLOURS:
● Black paint

ACCESSORIES: Turn plate, soapstone top, glass
or steel floor plate, external air connection.

JØTUL F 378 ADVANCE - NEW



Jøtul F 378 Advance has a clean expression with a door in cast iron. It sits on base with clean lines all the way to the floor.

EFFECT: min. 3.9 | max. 9.0 kW
FLUE EXIT OPTIONS: Top and rear,
Ø150 mm
WEIGHT APPROX.: 171 kg
DIMENSIONS, BASIC MODEL (HxWxD):
1155x443x453 mm

COLOURS:
● Black paint

ACCESSORIES: Removable shelf in the base, glass or steel floor plate, external air connection.

THE DESIGNER



With the F 370 Advance, it was important to identify exactly what it was that made it the world's most popular and award winning stove in the first place – and then figure out how to improve it further. We had an internal motto in the project group;

”Keep what works, improve what can be improved.”

– Kristin Schanche, Studio Director & Partner, Hareide design

JØTUL F 377 ADVANCE - NEW



Jøtul F 377 Advance includes elegant and heat-retaining décor from soapstone. It also features a practical storage space in the base with a detachable shelf for increased flexibility.

EFFECT: min. 3.9 | max. 9.0 kW
FLUE EXIT OPTIONS: Top and rear,
Ø150 mm
WEIGHT APPROX.: 221 kg
DIMENSIONS, BASIC MODEL (HxWxD):
1172x494x489 mm

COLOURS:
● Black paint

ACCESSORIES: Cast iron door for base, glass or steel floor plate, external air connection.

JØTUL F 377 HT ADVANCE - NEW



Jøtul F 377 HT Advance is a tall product made from cast iron and soapstone. It has an elegant and modern design where you can integrate hidden, heat accumulating Stones.

EFFECT: min. 3.9 | max. 9.0 kW
FLUE EXIT OPTIONS: Top and rear,
Ø150 mm
WEIGHT APPROX.: 271 kg
DIMENSIONS, BASIC MODEL (HxWxD):
1551x494x489 mm

COLOURS:
● Black paint

ACCESSORIES: Jøtul Heat Storage system, cast iron door for base, glass or steel floor plate, external air connection.

JØTUL F 371 HT ADVANCE - NEW



The Jøtul F 371 HT Advance has an open base with a practical storage space and a detachable shelf. This is a tall product where you can integrate hidden, heat accumulating stone. The wood stove has a sleek and modern design.

EFFECT: min. 3.9 | max. 9.0 kW
 FLUE EXIT OPTIONS: Top and rear,
 Ø150 mm
 WEIGHT APPROX.: 193 kg
 DIMENSIONS, BASIC MODEL (HxWxD):
 1534x443x453 mm

COLOURS:
 ● Black paint

ACCESSORIES: Jøtul Heat Storage system, cast iron door for base, removable shelf in the base, glass or steel floor plate, external air connection.

JØTUL F 378 HT ADVANCE - NEW



Jøtul F 378 HT Advance has an elegant cast iron door placed in front of the base storage which includes a detachable shelf. This is a tall product where you can integrate hidden, heat accumulating stone. The wood stove has a sleek and modern design.

EFFECT: min. 3.9 | max. 9.0 kW
 FLUE EXIT OPTIONS: Top and rear,
 Ø150 mm
 WEIGHT APPROX.: 200 kg
 DIMENSIONS, BASIC MODEL (HxWxD):
 1534x443x453 mm

COLOURS:
 ● Black paint

ACCESSORIES: Soapstone top, removable shelf in the base, glass or steel floor plate, external air connection.

JØTUL HEAT STORAGE SYSTEM

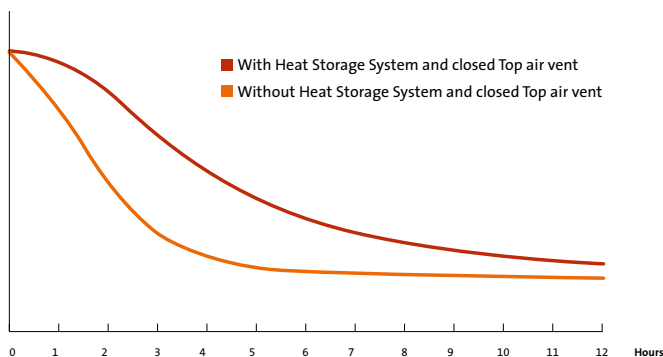

Hidden heat storage

The material that we use, features extremely good properties for heat storage and in combination with the technical design, the product will give off maximum heat for a long period after the fire is out. The heat storage system is compact and hidden in the top of the wood stove where the heat retaining stones * catch and store the heat that is produced in the combustion chamber.

Prolonged heating time

Jøtul's Heat Storage System can provide as much as 12 extra hours of heating time when the top air valve is closed. Read more at jotul.com.

* Only applicable when the heat accumulating stone (accessory) is added to HT elements.



Jøtul's Heat Storage System provides a great advantage with extra heat for up to 12 hours after the last log has been put on the fire.

1. Air intake.
2. Secondary air for clean combustion ensures that gases and particles in the smoke are transformed into heat.
3. Circulation of pre-heated air keeps the glass clean.
4. Stored heat is circulated and stored in the top of the stove when the air valve is closed.
5. The heat is released when the top air valve is open.

Top air valve

Lighting a fire with the top air valve open provides rapid heating. When the valve is closed, the heating time may be prolonged by up to 12 hours.

ENJOY THE HEAT FROM A MODERN CLASSIC

Jøtul F 373 is characterised by a timeless, award-winning design and it is one of the world's best-selling wood stoves. The combustion chamber is surrounded by glass windows for an optimal flame picture and it sits on a pedestal that may be rotated 360 degrees.



EFFICIENCY
73 %

LOG SIZE
30 CM

HEATING CAPACITY
51 - 100 M²

ECO CERTIFIED



reddot design award
winner 2011

JØTUL F 373 WHE



The Jøtul F 373 is characterised by its modern design where the combustion chamber sits on a pedestal. As the first and only wood stove in the world to have won the prestigious, international "Red dot design award: best of the best."

EFFECT: min. 3.6 | max. 7.0 kW

FLUE EXIT OPTIONS: Top and rear,
Ø150 mm

WEIGHT APPROX.: 156 kg

DIMENSIONS, BASIC MODEL (HxWxD):

1150x442x452 mm

COLOURS:

○ White enamel

● Black enamel

ACCESSORIES: Turn plate, soapstone top, glass décor for the front, sides and top as well as glass or steel floor plate, external air connection.

FLEXIBLE INSTALLATION

The Jøtul F 130-series is clean burning with a modern combustion system making it more efficient and reducing wood consumption by up to 40%. Integrated convection allows you to install the stove closer to combustible material. The designers behind this range is the award-winning design company Hareide Design



EFFICIENCY
83 %

LOG SIZE
25 CM, MAX 30 CM

HEATING CAPACITY
40 - 100 M²

ECO CERTIFIED



JØTUL F 134 - NEW



The Jøtul F 134 stands on a stylish base.

EFFECT: min. 2,8 | max. 7 kW
FLUE EXIT OPTIONS: Top and rear,
Ø150 mm
WEIGHT APPROX.: 140 kg
DIMENSIONS, BASIC MODEL (HxWxD):
1098x410x396 mm

COLOURS:

● Black paint

ACCESSORIES: Glass or steel floor plate
and external air connection.

JØTUL F 135 - NEW



The Jøtul F 135 is delivered with side-glasses which offers a great view to the fire, and a stylish base.

EFFECT: min. 2,8 | max. 7 kW
FLUE EXIT OPTIONS: Top and rear,
Ø150 mm
WEIGHT APPROX.: 140 kg
DIMENSIONS, BASIC MODEL (HxWxD):
1098x410x396 mm

COLOURS:

● Black paint

ACCESSORIES: Glass or steel floor plate
and external air connection.

JØTUL F 136 - NEW



The Jøtul F 136 stands on a stylish pedestal.

EFFECT: min. 2,8 | max. 7 kW
FLUE EXIT OPTIONS: Top and rear,
Ø150 mm
WEIGHT APPROX.: 120 kg
DIMENSIONS, BASIC MODEL (HxWxD):
1098x410x396 mm

COLOURS:

● Black paint

ACCESSORIES: Glass or steel floor plate
and external air connection.

JØTUL F 137 - NEW



The Jøtul F 137 is delivered with side-glasses which offers a great view to the fire and a stylish pedestal.

EFFECT: min. 2,8 | max. 7 kW
FLUE EXIT OPTIONS: Top and rear,
Ø150 mm
WEIGHT APPROX.: 120 kg
DIMENSIONS, BASIC MODEL (HxWxD):
1098x410x396 mm

COLOURS:

● Black paint

ACCESSORIES: Glass or steel floor plate
and external air connection.

USE 40% LESS WOOD



Jøtul's clean burning fireplaces and stoves are more efficient and require much less wood than the "old" non clean burning, to produce the same amount of heat. If you burn correctly, this can mean a reduction in wood consumption by up to 40 %. The environmental clean-burning stoves are entirely positive.

They reduce particulate emissions by 90 % set against old fireplaces. The dual combustion system also allows the gases and particles burning up before they go up the chimney.

EFFICIENT HEAT



Jøtuls clean burning fireplaces and stoves work well at low effect in terms of efficiency and particulate emissions. Since the stoves are more efficient they also use less wood so that the cost for heating is reduced. Jøtul offers a wide range stoves that are ideal for new homes.

WOOD STOVES WITH CHARACTER

Jøtul F 105 and F 305 combines 160 years of experience in making functional wood stoves with top notch design. The stoves have an unmatched view to the fire and their large burn chambers make it easy to position logs and kindling. They combine radiated and convected heat, making it easy to position and ensure a pleasant room temperature. An ash lip and soapstone top can be fitted as an optional accessory on some of the models.



JØTUL F 105 LL / F 105 SL



The Jøtul F 105 series has a confident and friendly appearance. In spite of its size the Jøtul F 105 is a wood stove that stands out from the rest. Some of the distinctive design elements of this wood stove include the large horizontal glass door, which offers a great view to the fire and the intuitive air controls that make it very user friendly. Standing on legs it has a light appearance, perfect for smaller rooms.

HEATING CAPACITY: Up to 86 m²
 EFFECT: min. 2.4 | max. 6 kW
 EFFICIENCY: 83 %
 LOG SIZE : 33 cm
 FLUE EXIT OPTIONS: Top and rear, Ø 125 mm
 WEIGHT APPROX.: 97 kg
 DIMENSIONS, BASIC MODEL (HxWxD):
 690x410x350 mm
 550x410x350 mm (SL - Short legs)



COLOURS:
 ● Black paint
 ○ White enamel

ACCESSORIES: Floor plate in steel or glass, soapstone top, ash lip, handle for ashdrawer, outside air kit, heat shield.

JØTUL F 105 B



The Jøtul F 105 is also available on a closed base version which follows the shape of the stove down to the floor. The unbroken lines and smooth surface of the cast iron gives the clean design. Jøtul F 105 is designed to perform optimally at low heat output, while being robust enough to fend off cold snaps.

HEATING CAPACITY: Up to 86 m²
 EFFECT: min. 2.4 | max. 6 kW
 EFFICIENCY: 83 %
 LOG SIZE : 33 cm
 FLUE EXIT OPTIONS: Top and rear, Ø 125 mm
 WEIGHT APPROX.: 107 kg
 DIMENSIONS, BASIC MODEL (HxWxD):
 690x410x350 mm



COLOURS:
 ● Black paint
 ○ White enamel

ACCESSORIES: Floor plate in steel or glass, soapstone top, handle for ashdrawer, outside air kit, heat shield.

JØTUL F 305 LL / F 305 SL



The Jøtul F 305 on legs has a light touch about it, focusing on showcasing the flames and the fire within. The horizontal format of the burn chamber makes it easy to burn large pieces of wood. Intuitive air controls makes it user friendly and the ash solution is easily accessible behind the front door.

HEATING CAPACITY: Up to 145 m²
 EFFECT: min. 3.7 | max. 10.0 kW
 EFFICIENCY: 79 %
 LOG SIZE : 41 cm
 FLUE EXIT OPTIONS:: Top and rear,
 Ø150 mm
 WEIGHT APPROX.: 143 kg
 DIMENSIONS, BASIC MODEL (HxWxD):
 850x560x420 mm
 650x560x420 mm (SL - Short legs)



COLOURS:
 Black paint
 White enamel

ACCESSORIES: Floor plate in steel or glass, soapstone top, ash lip, outside air kit, heat shield.

JØTUL F 305 B



The Jøtul F 305 sits on a solid base and offers the possibility to store wood below the stove firebox. The large door, which covers the ash solution, offers a great view to the fire.

HEATING CAPACITY: Up to 145 m²
 EFFECT: min. 3.7 | max. 10.0 kW
 EFFICIENCY: 79 %
 LOG SIZE : 41 cm
 FLUE EXIT OPTIONS:: Top and rear,
 Ø150 mm
 WEIGHT APPROX.: 167 kg
 DIMENSIONS, BASIC MODEL (HxWxD):
 850x560x420 mm



COLOURS:
 Black paint

ACCESSORIES: Floor plate in steel or glass, soapstone top, outside air kit, heat shield.

A NEW DESIGN ICON



Jøtul and the Norwegian designers Anderssen & Voll have with the Jøtul F 105 and F 305, made timeless and clean burn cast iron stoves which offer a great view to the fire. Both stoves are user friendly and emphasise functionality and thermal properties. The large combustion chamber has ample space for firewood, it is easy to light up and the combustion is optimal.

The Jøtul F 305-series has also won the prestigious international design award Red dot design award and the Norwegian Award for Design Excellence.

Jøtul F 305-series has won the Norwegian Award for Design Excellence and was nominated for Honours Award For Design Excellence. Are also winner of "Red Dot Design Award winner 2015".



reddot design award
 winner 2015

THE INTERIOR DESIGNERS FAVOURITE

The Jøtul F 160 series consists of six main models, with or without side glass and different bases. Parts of this series may be clad in soapstone for decoration and heat retaining properties. With soapstone the wood stove keeps more of the heat while the fire is going. It is adapted to modern houses and is suitable for low effect heating. This wood stove burns at an optimal level from 3.7 kW.



EFFICIENCY
83 %

LOG SIZE
33 CM

HEATING CAPACITY
53 - 129 M²



reddot design award
winner 2011

JØTUL F 162



Jøtul F 162 is characterised by its sleek look and three sturdy legs that give the wood stove an easy and modern look.

EFFECT: min. 3.7 | max. 9.0 kW
FLUE EXIT OPTIONS: Top and rear,
Ø150 mm
WEIGHT APPROX.: 115 kg
DIMENSIONS, BASIC MODEL (HxWxD):
903x450x446 mm

COLOURS:
● Black paint

ACCESSORIES: Soapstone top, glass or steel floor plate, external air connection and cover for external air (matt black only), 100 mm short legs (BP only).

JØTUL F 163



Jøtul F 163 features large side glass and three sturdy legs that give the stove an easy and modern look. Choose between black paint surface or maintenance free white enamel.

EFFECT: min. 3.7 | max. 9.0 kW
FLUE EXIT OPTIONS: Top and rear,
Ø150 mm
WEIGHT APPROX.: 115 kg
DIMENSIONS, BASIC MODEL (HxWxD):
903x450x446 mm

COLOURS:
● Black paint
○ White enamel

ACCESSORIES: Soapstone top, glass or steel floor plate, external air connection and cover for external air, 100 mm short legs (BP only).

JØTUL F 165



Jøtul F 165 has large side glass and a practical storage space in the base where you can hide accessories. You can also install a hidden, custom-made companion set.

EFFECT: min. 3.7 | max. 9.0 kW
FLUE EXIT OPTIONS: Top and rear,
Ø150 mm
WEIGHT APPROX.: 145 kg
DIMENSIONS, BASIC MODEL (HxWxD):
1033x450x447 mm

COLOURS:

● Black paint

ACCESSORIES: Soapstone top, glass or steel floor plate, external air connection and companion set.

JØTUL F 165 S



Jøtul F 165 S has large side glass, heat retaining soapstone and a practical storage space in the base. While the wood stove is in use, the soapstone preserves heat which is slowly released into the room after the fire is out.

EFFECT: min. 3.7 | max. 9.0 kW
FLUE EXIT OPTIONS: Top and rear,
Ø150 mm
WEIGHT APPROX.: 225 kg
DIMENSIONS, BASIC MODEL (HxWxD):
1090x517x489 mm

COLOURS:

● Black paint

ACCESSORIES: Steel or glass floor plate, external air connection and companion set.

JØTUL F 166



Jøtul F166 has an elegant pedestal base which, with time, has become an award winning signature design for Jøtul.

EFFECT: min. 3.7 | max. 9.0 kW
FLUE EXIT OPTIONS: Top and rear,
Ø150 mm
WEIGHT APPROX.: 140 kg
DIMENSIONS, BASIC MODEL (HxWxD):
1033x450x447 mm

COLOURS:

● Black paint

ACCESSORIES: Soapstone top, glass or steel floor plate and external air connection.

JØTUL F 167



Jøtul F 167 is characterised by large side glass and the pedestal base which, with time, has become an award winning signature design for Jøtul.

EFFECT: min. 3.7 | max. 9.0 kW
FLUE EXIT OPTIONS: Top and rear,
Ø150 mm
WEIGHT APPROX.: 140 kg
DIMENSIONS, BASIC MODEL (HxWxD):
1033x450x447 mm

COLOURS:

● Black paint

ACCESSORIES: Soapstone top, glass or steel floor plate and external air connection.

SAFE WITHOUT FIREWALL

Jøtul F 260 and F 480-series are both convection stoves, with a lower surface heat, which makes it possible to put them close to combustible materials. The large glass offers a great view to the flames. The discrete designs are easily matched with any architectural style.



JØTUL F 263



Jøtul F 263 has large side glass and room for a companion set hidden behind the base door. The wood stove is a convection stove and is well suited for installation close to combustible material.

HEATING CAPACITY: 53 - 129 m²
 EFFECT: min. 3.7 | max. 9.0 kW
 EFFICIENCY: 82 %
 LOG SIZE: 33 cm
 FLUE EXIT OPTIONS: Top and rear, Ø150 mm
 WEIGHT APPROX.: 160 kg
 DIMENSIONS, BASIC MODEL (HxWxD): 1087x519x491 mm

COLOURS:

● Black paint

ACCESSORIES: Soapstone top, fan, external air connection set, glass or steel floor plate and companion set.



JØTUL F 263 S



In addition to large side glass, Jøtul F 263 S has large soapstone panels integrated in the design. They retain heat while the wood stove is in use and releases it slowly back into the room after the fire is out.

HEATING CAPACITY: 53 - 129 m²
 EFFECT: min. 3.7 | max. 9.0 kW
 EFFICIENCY: 82 %
 LOG SIZE: 33 cm
 FLUE EXIT OPTIONS: Top and rear, Ø150 mm
 WEIGHT APPROX.: 240 kg
 DIMENSIONS, BASIC MODEL (HxWxD): 1120x519x491 mm

COLOURS:

● Black paint

ACCESSORIES: External air connection set, glass or steel floor plate and companion set.



JØTUL F 481



The Jøtul F 481 has architectural, clean lines that follow the wood stove's shape all the way to the floor. There is practical storage space for accessories, so that you can keep the area around the stove clutter-free. The shelf in the base comes as standard, but may be removed if you so wish.

HEATING CAPACITY: Up to 143 m²
EFFECT: min. 3.5 | max. 10.0 kW
EFFICIENCY: 75 %
LOG SIZE: 30 cm
FLUE EXIT OPTIONS: Top and rear,
Ø150 mm
WEIGHT APPROX.: 198 kg
DIMENSIONS, BASIC MODEL (HxWxD):
1180x466x460 mm

COLOURS:

● Black paint



ACCESSORIES: Floor plate in steel or glass,
kit for outside air.

JØTUL F 483



The Jøtul F 483 is characterised by Jøtul's bestselling signature design, where the wood stove sits on a pedestal. Top mounted with turntable (accessory) it is also possible to rotate the stove 360 degrees to enjoy the flames from several angles or locations in the room.

HEATING CAPACITY: Up to 143 m²
EFFECT: min. 3.5 | max. 10.0 kW
EFFICIENCY: 75 %
LOG SIZE: 30 cm
FLUE EXIT OPTIONS: Top and rear,
Ø150 mm
WEIGHT APPROX.: 186 kg
DIMENSIONS, BASIC MODEL (HxWxD):
1180x466x460 mm

COLOURS:

● Black paint

ACCESSORIES: Floor plate in steel or glass,
kit for outside air, rotating kit.



JØTUL F 520



Jøtul F 520 offers a wide expanse of glass, the flames can be fully enjoyed from three sides of the stove. With a special glass coating feature, the glass stays clean. The smart construction of the air valves makes the stove easy to light and is user friendly. The white enamelled burn plates also offer a clean and light view of the burn chamber when the stove is not in use. In the base of the stove there is a practical room for wood storage.

HEATING CAPACITY: Up to 143 m²
EFFECT: min. 3.5 | max. 10.0 kW
EFFICIENCY: 77 %
LOG SIZE: 50 cm
FLUE EXIT OPTIONS: Top, Ø 150 mm
WEIGHT APPROX.: 180kg
DIMENSIONS, BASIC MODEL (HxWxD):
1000x594x532 mm

COLOURS:

● Black paint

ACCESSORIES: Ash lip, floor plate in steel or glass, outside air kit.



DESIGN CLASSICS

The design of the Jøtul F602 and Jøtul F118 are without doubt synonymous with the Jøtul brand. Taking their inspiration from traditional designs these models are fine pieces of heating furniture. Jøtul F602 can boast over 2 million units sold worldwide since its introduction.

JØTUL F 602



Jøtul F 602 is one of Jøtul's timeless classics. Designed in the late 1930's by architects Blakstad and Munthe-Kaas and decorated by sculptor Ørnulf Bast. It has since gone through several technical upgrades and today it features modern and clean combustion. It is easy to place, offers efficient heating properties and comes with a practical cooking plate on the top. Available in clean burn or standard burn models.



HEATING CAPACITY: Up to 121 m²
EFFECT: min. 2.3 | max. 8.5 kW
EFFICIENCY: 74 %
LOG SIZE : 40 cm
FLUE EXIT OPTIONS: Top and rear, Ø 125 mm
WEIGHT APPROX.: 78 kg
DIMENSIONS, BASIC MODEL (HxWxD):
320x640x480 mm

COLOURS:

- Black paint
- Blue black enamel (clean burn only)

ACCESSORIES: 602 adaptor.



JØTUL F 118



Jøtul F 118 is a timeless classic which has been upgraded by the inclusion of clean-burn technology and new details. It was designed in the late 1930's, amongst others by the famous artist Ørnulf Bast. The wood stove has a deep combustion chamber that caters up to 60 cm logs and offers exceptionally long burn-time. On the top it has a practical cooking plate. The front of the wood stove is decorated with an ancient Norwegian prayer that was believed to keep the fire lit and the dark forces away from the house.



HEATING CAPACITY: Up to 157 m²
EFFECT: min. 4.0 | max. 11.0 kW
EFFICIENCY: 73 %
LOG SIZE : 60 cm
FLUE EXIT OPTIONS: Top, rear and sides, Ø115 mm
WEIGHT APPROX.: 145 kg
DIMENSIONS, BASIC MODEL (HxWxD):
785x361x734 mm

COLOURS:

- Black paint

ACCESSORIES: Side and rear heat shields.

CONSIDERATIONS WHEN INSTALLING A STOVE

Talking to professionals from our network of dealers early on, can save you both time and money. They can give you useful advice that is fit for your needs, your living situation and of course, your budget. Here are some issues that you should think through or investigate before you start the process of buying a new stove. They are relevant whether you go to one of Jøtul's network of dealers or if you want to do most of the work yourself (subject to planning permission).

Heating effect and living area.

In order to get the most enjoyment from your stove, it is very important that the size is right for your living area and heating needs. If the stove is too big, you will constantly be using it shut down because you will not need the heat and end up with soot on the glass and in your chimney because it is not being run hot enough. (Please see the information on our clean-burn system). If the wood stove is too small, it will be over fired and its lifetime will be considerably reduced due to the excessive heat.

The dealer needs information about living area and type of insulation in your home in order to give you good advice. Normally, the need for heating in UK homes is about 1 kilowatt for every 14 cubic metres. To work out your requirements, multiply your room width and length measured in metres, by your room height in metres (i.e. 5m x 7m = 35 x 2.5m = 87.50). This means that your room, with a normal sized window and number of doors, has a volume of 87.5 cubic metres and will need approximately a $(87.5 \div 14)$ 6 kW Jøtul stove. This can be reduced or increased by type of insulation, the number of windows, ceiling height and so on.

Ventilation

In order to function properly, the stove needs air. The chimney pulls air through the stove, but if your house is very well sealed and insulated, or if mechanical ventilation is fighting the natural draught in the chimney, you can experience problems with the function of the stove. The recommended solution is to connect so-called "outside air" or "closed combustion" to the stove. If you live in a house with new and tight insulation or have mechanical extraction, it is important that you consider this when you plan the installation of your stove.

Window glass and insulation

Old and draughty houses with poor insulation need considerably more heating than houses with proper insulation and triple glazed windows. The scope of the heat loss in your home is something that you know best, but if you reside in a low energy house or a newer house, it is important to choose a stove that works well on low effect. Jøtul F 160 and F 260 series are great examples of these types of wood stoves – they burn optimally even at 3kW.

Chimney

Most problems with stoves stem from the chimney having incorrect dimensions or not working properly. In order for a stove to work optimally, a chimney with an internal diameter that is bigger than the flue outlet on the stove should be attached. In the installation and User Guides you find information about the necessary draught for the different products to function optimally.

A rule of thumb is that 1 metre of chimney creates 4 Pascal of draught. Few stoves can function on less than 12 Pascal. Sharp bends on the flue outlet reduces the draught. If you are unsure about how your chimney works, the Jøtul retailer or the Chimney Sweep Association can help you. You can also get help to renovate or line your old chimney or alternatively install a steel chimney.

Steel chimneys are reasonably priced and a satisfactory alternative to the traditional brick chimney.

Where the stove should be installed

Different stoves have different features. Some are designed to be placed close to flammable material, while others require a fireproof barrier in order to be placed close to the wall. A drawing that shows where the stove should be placed in relation to the chimney outlet, fireproof wall and furniture will be of great help when you seek advice with the experts.

Suitable hearth requirements.

Most of Jøtul's wood stoves are tested to EN 13240, part of which requires that the stove does not increase the temperature of the hearth the stove is sited on above 100 degrees centigrade.

Current UK building regulations state that if an appliance does not raise hearth temperature above 100 degrees centigrade then the hearth does not need to be constructional and a supplementary hearth may be used. Your Jøtul dealer or local building control officer should be consulted for clarification and further instruction.

Installation

In the UK the installation should be carried out by a HETAS registered installer.



COMPACT AND PLACEMENT FRIENDLY

Jøtul F 100 is a compact stove with a great view of the fire. This stove is small enough to work even in the smallest of rooms while still being powerful enough to heat every corner.

JØTUL F 100 / JØTUL F 100 SE



Jøtul F 100 is a compact wood stove with capacity for logs size up to 40 cm. It has a small internal ash removal solution that makes removing the ashes an easy job (multi-fuel version only). The wood stove has a large glass door providing a great view of the burning logs and is characterised by a traditional pattern used in Norwegian craft work.

Jøtul F 100 SE version is plain door, multifuel and black paint only.



HEATING CAPACITY: Up to 107 m²

EFFECT: min. 2.7 | max. 7.5 kW

EFFICIENCY: 78 %

LOG SIZE : 40 cm

FLUE EXIT OPTIONS: Top and rear, Ø 150 mm

WEIGHT APPROX.: 97 kg

DIMENSIONS, BASIC MODEL (HxWxD):

570x528x336 mm

COLOURS:

- Black paint
- Blue black enamel (multi-fuel only)
- Ivory enamel (multi-fuel only)

ACCESSORIES: Long legs (215 mm),

Rear heat shield.



JØTUL F 8 TD



We wanted a classic, elegant look when we designed the Jøtul F 8. One that would complement any interior decor. Inspired by North American classic colonial design, we created a stove beautiful enough to become a cherished piece of furniture.

HEATING CAPACITY: Up to 135 m²

EFFECT: nom. 8.0 kW

EFFICIENCY: 75 %

LOG SIZE : 46 cm

FLUE EXIT OPTIONS: Top and rear, Ø 150 mm

WEIGHT APPROX.: 143 kg

DIMENSIONS, BASIC MODEL (HxWxD):

760x666x430 mm

COLOURS:

- Black paint

JØTUL F 400 AND JØTUL F 400 SE



Jøtul F 400 is a large wood stove, with room for logs of up to 50 cm. This model has a large external ash removal solution which facilitates convenient emptying of the ashes. A practical ash lip catches ashes and sparks.

The Jøtul F 400 Special Edition has the same characteristics as the standard F 400, but the Jøtul signature arches in the doors have been removed to improve the view to the fire.



HEATING CAPACITY: Up to 150 m²

EFFECT: min. 3.9 | max. 10.5 kW

EFFICIENCY: 84 %

LOG SIZE : 50 cm

FLUE EXIT OPTIONS: Top and rear, Ø 150 mm

WEIGHT APPROX.: 158 kg

DIMENSIONS, BASIC MODEL (HxWxD):

744x670x597 mm

Also available in Gas



COLOURS:

- Black paint
- Blue black enamel (F 400)
- Brown majolica enamel (F 400)
- Ivory enamel (F 400)

ACCESSORIES: 80 mm External air connection, short legs (155 mm).

JØTUL F 500 AND JØTUL F 500 SE



The Jøtul F 500 has one of the largest styled doors available, which allows for an unbridled view of the flame picture through timeless 'gothic' design.

Side and front door loading options allow for the stove to be positioned in a multitude of settings. At 9 kW rated heat output, the Jøtul F 500 is large enough to be the primary heat source in most homes.



HEATING CAPACITY: Up to 157 m²

EFFECT: min. 4.0 | max. 11.0 kW

EFFICIENCY: 78 %

LOG SIZE : 55 cm

FLUE EXIT OPTIONS: Top and rear, Ø 150 mm

WEIGHT APPROX.: 200 kg

DIMENSIONS, BASIC MODEL (HxWxD):

715x720x420 mm

COLOURS:



- Black paint
- Blue black enamel (F 500)
- Ivory enamel (F 500)

ACCESSORIES: 80 mm External air connection.

JØTUL F 600



With all of the technological features of its smaller cousins, the Jøtul F 600 is indeed a classic wood stove. It is designed to have room for considerable sized logs and has a large firebox volume to heat much larger rooms. Bigger is definitely best. In addition, it is superbly crafted with a side-loading door for added convenience and an easily accessed ash pan.

HEATING CAPACITY: Up to 170 m²

EFFECT: min. 4.0 | max. 12.0 kW

EFFICIENCY: 78 %

LOG SIZE : 55 cm

FLUE EXIT OPTIONS: Top and rear, Ø 150 mm

WEIGHT APPROX.: 200 kg

DIMENSIONS, BASIC MODEL (HxWxD):

800x733x410 mm

COLOURS:

- Black paint
- Blue black enamel

ACCESSORIES: 100 mm External air connection.

FUNCTIONAL ELEGANCE

This group of freestanding stoves has, over the years gained a reputation as one of the best on the market, if you're concerned with warmth, quality and longevity. Here you will find both small and large stoves, which means that you can always find one that suits your needs. They are easy to use and have a very broad output range, which means that they work equally well on a mild autumn evening as on a cold winter day.

EFFICIENCY
78 %

LOG SIZE
40 CM

HEATING CAPACITY UP TO
129 M²

ECO CERTIFIED



JØTUL F 3



Jøtul F 3 has a horizontal format which provides a spacious combustion chamber for larger logs. The glass door provides a perfect view of the burning logs. An external ash removal solution ensures easy ash removal. A practical ash lip catches sparks or ashes in an efficient way.

EFFECT: min. 3.4 | max. 9.0 kW
FLUE EXIT OPTIONS: Top, rear and sides,
Ø150 mm
WEIGHT APPROX.: 124 kg
DIMENSIONS, BASIC MODEL (HxWxD):
707x577x484 mm

COLOURS:

- Black paint
- Blue black enamel
- Brown majolica enamel
- Ivory enamel

ACCESSORIES: Short legs 155 mm.

Also available in Gas

JØTUL F 3 TD / MF 3



The F3 TD is a design classic. A dedicated wood stove available in black paint finish only. Enhancing any room with its presence, this really is a piece of furniture as well as a great source of heat.

Jøtul MF 3 is a true multi-fuel version of the iconic Jøtul F 3. The plain door gives an uninterrupted view of the fire. With primary air control on the ash pan door and secondary air via the control at the top of the stove, user friendliness comes as standard. Comes complete with an eye to remove bottom grate.

EFFECT: min. 3.4 | max. 9.0 kW
FLUE EXIT OPTIONS: Top, rear and sides,
Ø150 mm
WEIGHT APPROX.: 124 kg
DIMENSIONS, BASIC MODEL (HxWxD):
707x577x484 mm

COLOURS:

- Black paint

ACCESSORIES: Short legs 155 mm.

PURE JOY IN FRONT OF THE FIRE

Jøtul wood stoves and fireplaces are manufactured in Norway where they are subjected to some of the strictest regulations regarding the environmental world. The main ingredient is recycled cast iron. Wood is a renewable resource and a CO₂ neutral source of energy that does not contribute to the greenhouse effect.

Modern, clean burning wood stoves reduce emissions of particles by up to 90 % compared with older fireplaces.

Clean heating with CO₂ neutral products

A Jøtul product is amongst the cleanest products available on the market, so you can light your fire and feel good about it. Wood is a renewable resource and the combustion in a clean-burning wood stove is so efficient that you do not contribute to the greenhouse effect. The explanation is that the CO₂ that is produced during combustion does not exceed the amount that is absorbed when a new tree is planted and grows back. A clean-burning product also provides maximum utilisation of the energy in the wood and emits a minimum of particles. The Jøtul production takes place with a focus on both the internal and the external environment. This is your guarantee that there are no toxic heavy metals in the surface treatment and at production Jøtul is subjected to strict requirements regarding emissions. You have every reason to feel good when you relax in front of a fireplace from Jøtul. Our objective is to be at the global forefront regarding environmentally friendly fireplace technology. Hence, clean combustion is matter of fact to us. It is economical to be environmentally friendly. Jøtul's clean-burning fireplaces need significantly less wood than older, non clean-burning fireplaces to produce

the same amount of heat. If you use it correctly, this could mean as much as half of the wood consumption. You get maximum heat from burning wood without harming the environment and you save money due to lower wood consumption.

What do we mean by clean-burning?

Clean-burning means that the fireplace has a double combustion system that utilises the wood fuel in an optimal way and keeps pollution at an extremely low level. In this way, we achieve minimal smoke emissions because the fireplace utilises the energy in order to produce heat instead of smoke. Because the clean-burn system will only work when the firebox temperature reaches 350 degrees C, it is important to run your stove correctly, by using a small amount of fuel, often. If a stove is loaded up and shut down without reaching this temperature, then the moisture in the wood will condense and lead to chimney problems and blackening of the glass. A non clean-burn stove can be shut down more, but this leads to far greater emissions leaving the chimney, which in turn leads to more pollution in the atmosphere.

Recycling of cast iron

Jøtul has a strong commitment to research and development in order to have the cleanest possible production. Fireplaces from Jøtul are being produced at one of the cleanest and most modern foundries in the world. The raw materials are based on recycling of iron. Fireplaces from Jøtul are made of iron that has been melted down and recast again.

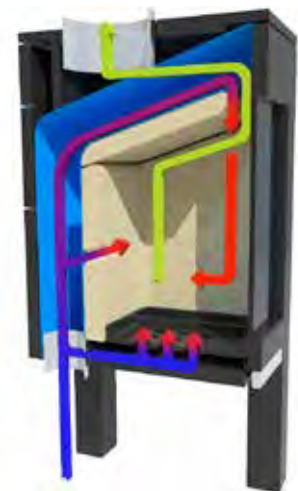

CLEAN & INSTANT

Jøtul gas products offer an alternative to their wood burning cousins, still offering the same aesthetics and high standard of build quality but in a clean and convenient fuel option.



JØTUL GF 300 BF/CF



The Jøtul GF 300 BF/CF is available as balanced or convectional flue. Its contemporary lines and arch double doors frame a hand crafted log set, flame and glowing embers with realism unrivalled in the fireplace history.

HEAT OUTPUT KW: NG 5.2 / LPG 5.4
HEAT INPUT KW: NG 6.8 / LPG 6.9
EFFICIENCY: 80.6 % CF & 76.6 % BF
FUEL EFFECT : Log
GAS TYPES : NG / LPG
FLUE EXIT OPTIONS: Top and rear, Ø 125 mm
FLUE SIZE: 125 mm
DIMENSIONS, BASIC MODEL (HxWxD):
700x565x330 mm

COLOURS:

- Black paint
- Blue black enamel
- Brown majolica enamel
- Ivory enamel

JØTUL GF 400 CF



The Jøtul GF 400 CF presents the perfect union of high efficiency and cast iron beauty. Its classic lines and Gothic arch double doors, frame a hand crafted log set. Complete with flames and glowing embers that give the Jøtul GF 400 CF unrivalled realism within the stove industry.

HEAT OUTPUT KW: NG 6.8 / LPG 7.2
HEAT INPUT KW: NG 8.7 / LPG 9.3
EFFICIENCY: 77.9 %
FUEL EFFECT : Log
GAS TYPES : NG / LPG
FLUE EXIT OPTIONS: Top and rear, Ø 125 mm
FLUE SIZE: 125 mm
DIMENSIONS, BASIC MODEL (HxWxD):
711x673x609 mm

COLOURS:

- Black paint
- Blue black enamel
- Brown majolica enamel

JØTUL GF 373 BF



Modern design with an elegant three-sided fire view, the Jøtul GF 373 BF utilises the new Jøtul Burner III to create an exceptional fire view from any angle. Based on the award winning Jøtul F 370 wood stove, the Jøtul GF 373 BF offers the same contemporary cast iron styling in a freestanding balanced flue stove complete with log fuel effect. The Jøtul GF 373 BF is the perfect combination of design and craftsmanship.

HEAT OUTPUT kW: NG 5.7 / LPG 5.5
HEAT INPUT kW: NG 6.9 / LPG 7.0
EFFICIENCY: 78.4 % (LPG) 82.2 % (NG)
FUEL EFFECT: Log
GAS TYPES: NG / LPG
FLUE EXIT OPTIONS: Top, Ø 150 mm
FLUE SIZE: 150/170 mm
DIMENSIONS, BASIC MODEL (HxWxD):
1150x442x452 mm

COLOURS:

- Black paint
- White enamel

GAS, CLEAN & CONVENIENT

Jøtul gas products offer quick and efficient heating. The range consists of classic and modern gas stoves in balanced and conventional flue versions and all with the same high standard of finish and cast iron as found on our wood burning products. Gas allows instant heat without any preparation or cleaning, after a long day at work your room can have a glow within seconds of arriving home.

Conventional flue appliances work by utilising your lined chimney or a prefabricated twin wall system whilst if this is not practical balanced flue is an option venting the stove vertically through a roof or horizontally through an adjacent wall.

Jøtul gas appliances are made with top quality recycled cast iron produced by our foundry in Norway. The technology and manufacturer of the finished products is at Jøtul North America, Portland, Maine where they have been pioneers in gas fire technology for the last 15 years and whose innovation include the trademarked Jøtul Heat fin and Jøtul burner system.

Before you consult your Jøtul dealer determine how large your room is in cubic metres, determine where you would like to site the appliance, do you have a chimney or adjacent wall? Where is your nearest gas point and have you an air brick in the room if you require a conventional flue product greater than 7.0 kW input.



JØTUL S 70 SERIES

INSTALLS DIRECTLY AGAINST A COMBUSTIBLE WALL

Jøtul S 71/ Jøtul S 72 is supplied with an integrated firewall and can be mounted directly against a combustible wall. It is made for corner installations and offers a great view of the fire. A soapstone shelf is standard. The insert is the bestselling Jøtul I 520, which offers glass on two sides and a state of the art combustion.







SURROUND

Factory assembled frames suited for Jøtul inserts might be a time and cost reducing alternative for you if you want a quick and simple fireplace. Most of them can be placed right onto a steel plate on the floor and normally there is no need for reinforcing the floor either.

JØTUL FS 91 / 92

INFO



Jøtul FS 91 and Jøtul FS 92 are flush with the large, arched glass door that provides the perfect view of the burning logs. The result is a fireplace with a slim and round shape. These fireplaces house the Jøtul F480 firebox.

HEATING CAPACITY: Up to 143 m²
 EFFECT: min. 3.5 | max. 10.0 kW
 LOG SIZE : 30 cm
 FLUE EXIT OPTIONS: Top and rear, Ø 150 mm
 TOTAL WEIGHT: 281 kg
 DIMENSIONS, BASIC MODEL (HxWxD):
 1570x525x480 mm

COLOURS:
 ● Black paint/lightweight concrete/Olivine

ACCESSORIES: Glass floor plate, black glass decorative plate (Jøtul FS 92, external air kit).



Jøtul FS 91 offers smooth sides that are flush with the large arched glass door in the Jøtul F 480 firebox.



Jøtul FS 92 has Art Deco style cut-outs on the sides. Tinted glass may be installed on the sides of the fireplace as an accessory.



JØTUL FS 73 / FS 74



Jøtul FS 73 and FS 74 are adapted to the insert Jøtul I 520 and have access to fire from three sides. They have a convenient storage at the base. If you want a very clean design this can be closed when setting up the fireplace. Jøtul FS 74 has an integrated firewall and can be mounted directly to combustible materials.

HEATING CAPACITY: 56 - 143 m²
 EFFECT: min. 3.9 | max. 10.0 kW
 LOG SIZE : 50 cm
 FLUE EXIT OPTIONS: Top and rear, Ø 150 mm
 TOTAL WEIGHT: 345/371 kg
 DIMENSIONS, BASIC MODEL (HxWxD):
 1690x574x530 mm (Jøtul FS 73)
 1690x574x600 mm (Jøtul FS 74)

COLOURS:

- Black paint/lightweight concrete



ACCESSORIES: Steel floorplate

JØTUL S 71 FR / 72 FL



Jøtul S 71 is made for Jøtul I 520 FR, which has glass in the front and on the right side of the insert. Jøtul S 72 is made for Jøtul I 520 FL, which has a glass front and glass on the left hand side of the insert. The light concrete elements are easy to build and the integrated firewall makes expensive wall insulation unnecessary.

HEATING CAPACITY: Up to 143 m²
 EFFECT: min. 3.9 | max. 10 kW
 LOG SIZE : 50 cm
 FLUE EXIT OPTIONS: Top and rear, Ø 150 mm
 WEIGHT: 402 kg
 DIMENSIONS, BASIC MODEL (HxWxD):
 1700x1065x685 mm

COLOURS:

- Black paint/lightweight concrete



ACCESSORIES: Floor plates in steel or glass, outside air connection, adapter for ventilated chimney.

IT IS EASY TO INSTALL A FIREPLACE

The number of elements depends on the size of the fireplace, but usually there are few parts involved and easy assembly. You will need an angle grinder or saw if you need to cut out room for the chimney. Please read the instruction manual before getting started.

Follow the installation instructions that come with the surround and insert step by step. It doesn't get easier than this.

Most people can install the easiest fireplaces in a day, while the bigger models require a bit more time. When the fireplace is finished, you should check for any imperfections or irregularities in the concrete, which will have to be filled to achieve the best possible result.

You should use sandpaper to check the fireplace and even out small irregularities and sharp edges before you paint it. Our fireplaces come ready spackled and three layers of white priming paint, so at least one top coat of paint is necessary.

Floor plates and shelves are accessories. Shelves do not come with all fireplaces; please see the specifications for each model. The Jøtul retailer might be able to help with a complete installation.





JØTUL I 400 HARMONY

A FLEXIBLE SERIES OF INSERTS

Jøtul I 400 Harmony is a medium-sized fireplace insert with a modern design. It features a large, foldable glass door for a perfect view of the burning logs. It has light coloured burn plates that makes the fireplace insert look light and attractive even when you don't have the fire lit.

READ MORE ABOUT THE JØTUL I 400 HARMONY ON PAGE 45.

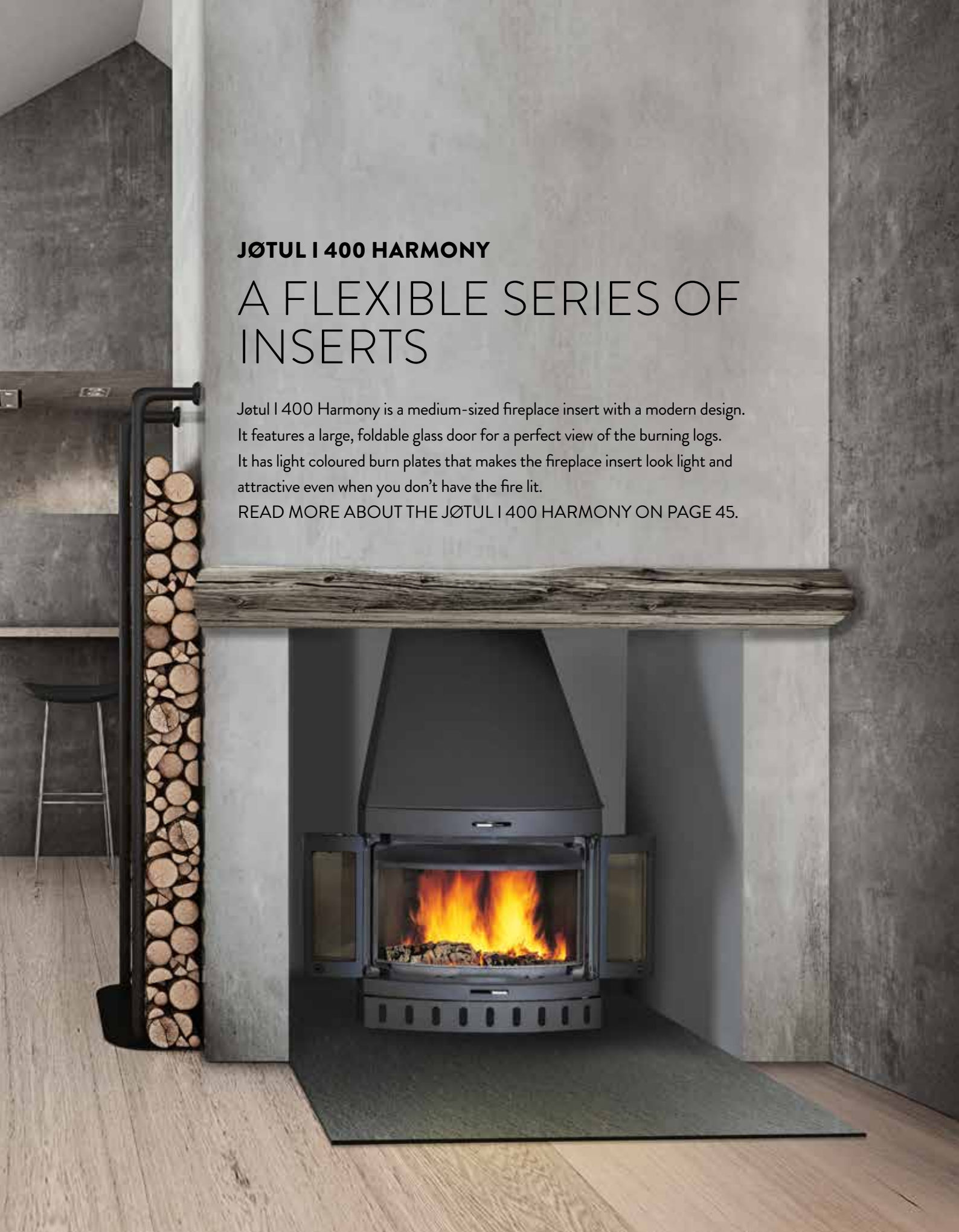

INSERTS

Jøtul's fireplace inserts are used to customise a fireplace, or they are included in factory assembled surrounds. When you choose to build a fireplace, it is a choice that you will have to live with for a long time. Hence, Jøtul focuses on a timeless design so that the insert is included as a natural part of the architecture in the room where it is placed. Cast iron inserts last for a very long time and do not degrade, so the doors, hinges and closing mechanisms remain reliable even after being exposed to long-term usage. This is important when building a fireplace that you want to have for a long time.



JØTUL I 520



Jøtul I 520 F



Jøtul I 520 FRL



Jøtul I 520 FR



Jøtul I 520 FL

The Jøtul I 520 series is a flexible insert system that consists of four inserts. You can choose whether you want glass on one, two or three sides. The design is timeless and the construction optimal and futuristic. Jøtul I 520 has enamelled burn plates which provide a light and airy flame picture. All glass has a heat-reflecting surface that ensures cleaner glass and better combustion. Even though the insert is large, it works well even at 3.9 kW effect.

HEATING CAPACITY: Up to 143 m²

EFFECT: min. 3.9 | max. 10.0 kW

EFFICIENCY: 77%

LOG SIZE: 50 cm

FLUE EXIT OPTIONS: Top and rear, Ø 150 mm

WEIGHT APPROX.: 110kg

DIMENSIONS, BASIC MODEL (HxWxD):

524x670x431 mm

COLOURS:

● Black paint

ACCESSORIES: Complete leg stand, door lock left, broad frames, cassette grids, external air connection and complete convection top.



WHAT ABOUT AN UPGRADE OF YOUR FIREPLACE?

A fireplace should preferably be great to look at and give us the warmth we need. A renewal of a fireplace will not only provide a design improvement, but also better heating efficiency and less emissions.

A family in Fredrikstad, Norway replaced an old Jøtul 17 with a new and effective insert; Jøtul I 520 FR. The family can now enjoy the flames from both the living room and kitchen.

The surround is custom built of Non-Combustible Building Materials from Jøtul Accessories.



GET FIVE TIMES MORE HEAT PER LOG

Jøtul C 520 cassettes are ideal for transforming old, open fireplaces into modern and efficient closed combustion systems.

Jøtul C 520 FL with glass in front and on the left side offers a wide expanse of glass and roomy flame picture.





JØTUL CASSETTES

The landscape 'air washed' doors on the Jøtul Cassettes not only give a wonderful view of the fire; they are the central features of these built in fireplaces. Ideally sized to fit most conventional fireplace openings, the Jøtul Cassettes offer convected heat circulation to reach out to the corners of your room. Capable of producing up to an impressive 12 kW heat output, the Jøtul Cassettes give you the pleasures of traditional home heating combined with an astounding fire view.

JØTUL I 18



Jøtul I 18 Panorama is a large insert in a contemporary design with large curved glass which offers a superb view of the logs burning. Jøtul I 18 Harmony is a large insert in a contemporary design with bi-folding glass doors which offers a superb view of the logs burning. With a canopy, they become an ideal and impressive inglenook appliance. It can be installed free-standing by the adaption of the supporting legs provided or with a matching curved base.

EFFECT: min. 3.0 | max.15.0 kW

EFFICIENCY: 81 %

LOG SIZE: 50 cm

FLUE EXIT OPTIONS: Top, Ø 175/200 mm

WEIGHT APPROX.: 186 kg

BASIC DIMENSIONS, BURN CHAMBER (HxWxD):

597x746x600 mm

COLOURS:

● Blue black enamel

ACCESSORIES: Canopy, Firescreen (panorama model only), Side Extension Panel, Top Extension Panel, Decorative Plinth.

JØTUL I 400



The Jøtul I 400 series offers modern design and technology. Jøtul I 400 Flat has a flat front and Jøtul I 400 Panorama has arched glass and both offer a great view of the burning logs. Jøtul I 400 Harmony has two doors that can be folded to the side to offer the open fireplace feeling.



HEATING CAPACITY: Up to 129 m²
EFFECT: min. 3.7 | max. 9.0 kW
EFFICIENCY: 74 %
LOG SIZE : 40 cm
FLUE EXIT OPTIONS: Top, Ø 150 mm
WEIGHT APPROX.: 125 kg
BASIC DIMENSIONS, BURN CHAMBER (HxWxD):
492 or 514 bi-fold version x640x422 mm

COLOURS:

● Black paint



ACCESSORIES: External air kit, installation kit for cassette, ash solution, grid, flat smoke canopy and decorative leg cover.

JØTUL C 24



The Jøtul C 24 cassette offers one of the world's largest views to the fire, compared to the size of the cassette. The clean design makes it suitable for any interior style. The burn chamber itself is surrounded by a convection box, making it ideal for transforming old, open fireplaces into modern and efficient closed combustion systems, whilst respecting the need to still have a great view to the fire.

HEATING CAPACITY: Up to 143 m²
EFFECT: min. 4.0 | max. 10.0 kW
EFFICIENCY: 78 %
FLUE EXIT OPTIONS: Top, Ø 150/175 mm
LOG SIZE: 50 cm
WEIGHT APPROX.: 136 kg
BASIC DIMENSIONS, BURN CHAMBER (HxWxD):
556/715/441 mm

COLOURS:

● Black paint

ACCESSORIES: Tangential fan, Kit for outside air, set of convection adaptors.

RENEWAL OF OLD FIREPLACE

Jøtul cassettes are ideally sized to fit most conventional fireplace openings. A renewal like this one from an old open fireplaces into a modern and efficient closed combustion system, will not only provide a design improvement, but also better heating efficiency and less emissions.

With a Jøtul C 400 Panorama the family still have a great view to the fire.

It is easier to change than you may think.



NO PATIO WITHOUT A FIREPLACE

In co-operation with Hareide Design, we developed the Jøtul Terrazza. This is an outdoor fireplace that you want to show off – it can be a part of a unified look using contemporary furniture and well-planned planting to bring it all together. The outdoor fireplace is made of Corten steel which after a short period of time develops a trendy oxidised surface finish.



CORTEN STEEL

GRILL

FIRE-SCREEN

USER FRIENDLY

JØTUL TERRAZZA

INFO



Jøtul Terrazza can be left outside the whole year to be enjoyed for both chilly summer evenings and cold autumn days.

WEIGHT APPROX.: 30 kg
DIMENSIONS (HxWxD): 1180/500/500 mm

ACCESSORIES: Grill, fire-screen.



The grill provides a large surface for grilling.



The fire-screen may be installed as necessary and is designed to allow for one side open.

FLUE PIPES



We offer a wide variety of flue pipes in both painted and enamel finishes, both of the highest quality.

FLOOR PLATES

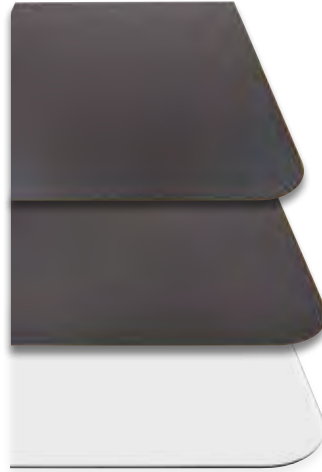

We have a wide selection of floor plates of different materials, shapes and colours.

COMPANION SETS



We offer a wide range of functional companion sets in a contemporary design.

WOOD BASKET



Wood baskets come in a wide range and different sizes, materials and colours.

FACTS TO NOTE WHEN YOU ARE LOOKING FOR A NEW FIREPLACE

How important is ventilation?

A fireplace needs a supply of air in order to avoid smoke spilling out of the fireplace and to ensure optimal combustion. External air is supplied through wall mounted air vents, a separate external air channel or it is connected directly to the fireplace when it is possible. Vents in the window frame are for the most part not sufficient.

Closed combustion

Today's requirements for new houses to be closed and requirements for "balanced" ventilation requires some kind of external air connection / air supply to the fireplace to ensure the correct combustion. Products featuring a closed combustion system collect air from a separate air channel directly to the stove through an outer wall or through the floor. Closed combustion also provides economic heating as it does not "steal" heated air to use for combustion. Building regulations

Where is the fireplace going to go? In order to get the optimal joy and use from the fireplace, it is important to choose the right shape, look, size and placement in the house. You might want to make a sketch showing the placement of the chimney in relation to the living area and perhaps the fireproof wall and the size of the fireproof wall. Your Jøtul retailer will provide help to place and choose a your new fireplace correctly.

requires that new houses install wood burning fireplaces with a closed combustion system.

What type of chimney do you have?

It is an advantage that you know the internal dimensions and height of the chimney when you choose your fireplace. If the cross-section is too small, the height is too low or there are too many fireplaces using one chimney, this often causes poor draught to the fireplace.

What load can your floor handle?

Fireplaces from Jøtul do not usually require reinforcements of the floor. However, if you wish to have a heavier fireplace surround, for example natural stone, it might be necessary to reinforce the floor.

What is your heating requirement?

The need for heating depends on the type of house you have, the insulation and climate.

A house with a normal amount of insulation, double-glazed windows and located in areas where the average temperature is -10 to -12 degrees, has a need for heat of 60 to 70 watts per m². In addition, it might be a good idea to calculate a bit extra for periods of extreme cold weather.

Heating capacity

The heating capacity are guidelines since building standards and hearth placement is very important. We have given an approximate square value, which we hope will make the choice of fireplace or wood stove easier. This is based on the stoves maximum output and it is based in a house with standard flueing and good insulation and central positioning of the stove. The same applies to the choice of wood, how hard you fire and if there is a new or closed building. The values are therefore to be regarded as normative and instructive.

DO YOU NEED HELP WITH INSTALLATION?

The Jøtul retailer often offers a complete installation service to ensure that the fireplace is installed according to all regulations. The product is delivered with installation instructions. The fireplace must be inspected by a qualified inspector, for example an approved business or approved local inspection authority, before use. After the inspection has been carried out, a declaration or copy of the inspection form must be sent to the local chimney sweep association to report that changes were made to an existing fireplace or a new one was installed.

QUALITY OF JØTUL ENAMEL

Jøtul was the first manufacturer on the market with porcelain enamel for wood stoves more than 50 years ago. Durable, semi-gloss porcelain enamel surfaces are not only the best, but also the most beautiful. It highlights the contrast between textured and smooth surfaces in a very aesthetic way.

"An enamelled surface is durable and maintenance-free"

The secret behind the remarkable enamel quality is the production process. The moulding process itself is vital to get cast iron of the correct quality, which in turn is a requirement for optimal enamel quality. Before the products are coated with the enamel, they receive one more round of sandblasting to remove oxides and graphite from the surface and to make it rougher so that the enamel can adhere itself properly to the cast iron.

This is why we can guarantee the best enamel quality that will last "forever".

Today, we deliver products in different degrees of gloss. Some are matt gloss, others are glossy and we also offer products with majolica enamel.

The common denominator for all the enamelled surfaces is that they are durable and maintenance-free, so that you and your family can enjoy your Jøtul wood stove for several generations.

With use enamel adopts a "crazed" finish. This is normal and to be expected and enhances the appearance of a Jøtul stove.

Do not use wet cloths to clean enamel. This will allow moisture to get under the enamel and cause it to lift. This will not be covered under warranty.

A SMALL SELECTION OF COLOURED SURFACES



Blue black enamel



Brown Majolica enamel



Ivory enamel

BURNING WOOD/ TIPS ABOUT WOOD

In order to check if the wood is dry enough, you can bang the logs against each other and listen out for a “singing” sound. If you put a log of wood in a tight plastic bag in a warm room, moisture on the inside of the bag reveals whether the wood is too moist. However, dry wood is most easily recognised by visible dry cracks.

Tips for burning wood

There are several ways to light a fire, but it is always important to pay attention to what you put in. You should never burn painted or impregnated wood or plastic containing chlorine (PVC), which give off extremely toxic gases. Do not use driftwood as firewood. It contains salt which turns into chlorine when it is burned. Driftwood should be washed and left outside in all types of weather for at least a couple of years. Wood that is stored outside or in cold rooms should be brought in at least

If you plan to chop the wood yourself, this should be done early in the spring. The wood is chopped in shorter lengths before it is split and stacked outside through the summer. The wood contains a lot of water, so remember to store the wood in an airy place where it can get rid of this water.

24 hours before you plan to use it so that it reaches room temperature. Chop the kindling wood to approx. 4 cm diameter. This will make it easier for you to start the fire and provide more rapid draught in the chimney.

Before you light the fire, you should open all air vents. Some wood stoves only have one, while others have two. The easiest method for lighting a fire is to:

- Put two logs on the bottom of the burn chamber and stack kindling wood in layers up to the holes for tertiary air. Finish with a semi-large log on the top.
- Put 2 or 3 firelighters or similar underneath the top layer of kindling wood and light up.
- Under normal draft conditions, you may now close the door and the fire will take care of itself.

Another variant is to put two big logs on either side of the fireplace. Put some crumpled up

paper in-between them and put the kindling wood on top. Later you can add paper as necessary. It might be necessary to make sure that the fire gets enough air for the first 10-15 minutes. Depending on the draught conditions, you may need to supply extra air with the stove door ajar.

Add fuel to the fire often, but only a little fuel at a time. If you burn the fire too hard, the heat load in the chimney might get unnecessarily hard. Burn in a moderate manner. The best indication of a good fire is almost invisible smoke from the chimney.

Jøtul strongly recommend the use of a thermometer on the stove or flue pipe to assist in the operation of your stove and a moisture meter to monitor the moisture content of your wood.



Lighting a fire is easy if you follow the instructions from Jøtul. Please read our instructions on jotul.com for more tips and good advice.

25 YEARS – THE LONGEST GUARANTEE ON THE MARKET



We wish to offer our customers the best of the best, and for this reason all products are handmade in Norway from the best available materials. The exceptional durability is the reason that Jøtul offers a 25 year warranty against failure due to faulty manufacture - the longest on the market.

Your satisfaction revolves around our guarantee all Jøtul stoves and fireplaces are covered by a conditional 25-year guarantee from the date of purchase, against failure due to faulty manufacture if installed by a suitably qualified engineer.

The 25 year guarantee is only available for appliances that have been purchased from an authorised Jøtul dealer and have been registered with Jøtul UK at www.jotulgroupspares.com you may also ask your authorised dealer to register your new appliance for you.

Failure to buy your appliance from an authorised dealer and/or not registering your purchase will by default result in only our standard 12 month guarantee being given.

Guarantee includes all components except consumables (grates and flame path equipment) and does not include labour.

We refer to full terms and conditions on our webpage: jotul.com/UK - Register your stove

INTERNET POLICY - CONSUMERS

Jøtul's products are sold through a network of highly trained retailers, able to offer you the very best advice on the most suitable stove for your individual needs and circumstances, with the option of installation and appropriate after sales service for your purchase.

In order to ensure that you benefit from this, we do not recommend purchasing a Jøtul stove over the Internet where this level of advice and service may not be available. If you do decide to buy your stove over the

Internet, ensure that you buy from a dealer who can offer expert advice on the most suitable product for your needs, and who is able to install your stove and service it when necessary.

In particular, we would suggest that you avoid buying Jøtul stoves over the Internet, especially from a retailer who is not local to you, and who is, therefore, unlikely to be able to provide you with the appropriate support.

WHAT IS THE CORRECT HEATING FOR YOU?

When buying a wood stove, the question of "radiation vs. convection" often comes up in the process, and this is perhaps where we often go wrong. These two heat sources work quite differently and will provide a substantially different indoor climate, so it is important to choose correctly. We explain the differences and help you make your decision.

But first; how do you get the perfect indoor climate?

Despite the common perception, the most important objective of a heat source is not to increase the temperature by a certain number of degrees. The most important feature of a heat source is to maximise how comfortable

you are in a room or a house. This topic has received quite a bit of research, for example by David Zijdemann at Skarland Press, and us humans are most comfortable in a room where our feet are nice and warm (we like heated flooring), where it is comfortably warm in the chest area and the air that we breathe

in is not too warm. This is something that most of us can relate to. To sum up, we like heat sources that keep our feet warm, while not making the air that we breathe warm and heavy.

CONVECTION HEATING

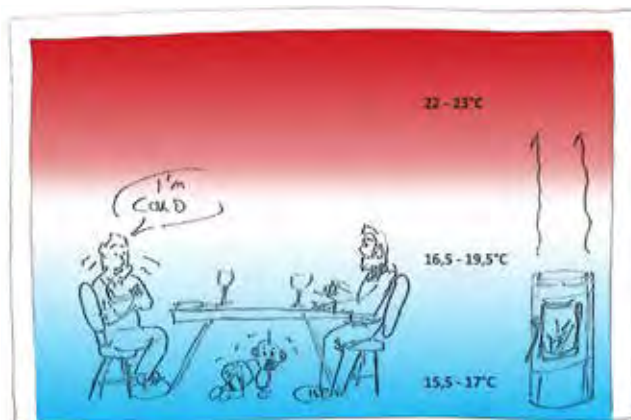

RADIATION HEATING

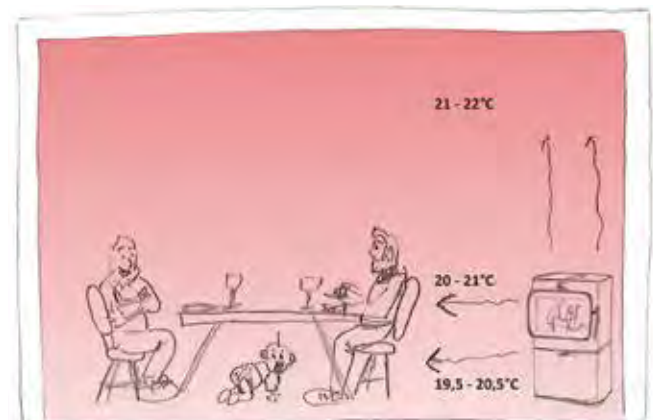

The drawings illustrate the different temperature zones created in a room heated by a radiation stove and a convection stove. The radiation stove provides an even temperature throughout the entire room.

Radiation heating provides the best comfort

Radiation heating is simply the transferring of heat from a warm element to colder areas in a room. It is heat transferred quickly. Radiation stoves heat up objects and surfaces in the room, which is gently radiated back into the surroundings. In this way, you get a room that is evenly heated from floor to ceiling, while even the floor and furniture surfaces are warm to the touch. Other sources that provide radiation heating are the sun, big radiators, floor heating and cast iron wood stoves.

Convection provides the least surface heating to the surroundings

Convection heating is defined by air being heated up while it rises between two surfaces. Cold air is drawn in under the stove, heated up and then rises to the ceiling where it is gradually pushed down in a warm "layer". Laurent Georges, Associate Professor at the Department of Energy and Process Engineering at SINTEF, concludes quite clearly in the research project Stablewood (2014) that convection in wood stoves will

create a much bigger difference in temperature between floor and ceiling, which is the opposite effect of what you want from a heat source in order to maximise indoor comfort. The reason that Jøtul still offer convection on some of our wood stoves is quite simply that not all houses are equipped with a fireproof wall. Hence, we have to send the heat up under the ceiling instead of into the room and onto furniture, floors and surfaces. However, this is not something that we recommend.



→ RADIATION HEATING
- - - CONVECTION HEATING

RADIATION HEATING:

- Provides rapid heating
- Heats in a “wide” range when heat rays pass in straight lines from the heat source
- Ideal in rooms where there are high ceilings
- The warm rays warm objects and surfaces in the room

CONVECTION HEATING:

- The stoves are easy to place because they have lower surface temperature
- Warms the air in the room. As the warm air rises in the room, it can be distributed with help of a fan

”Research documents that humans feel best inside a room when it is warm air in the lower region – and colder air in the higher regions.”

– David Zijdemann, Skarland Press



Jøtul F105 combines radiated and convected heat in equal measures. The optional heat shield allows the stove to be positioned only 10 cm from combustible walls.

TECHNICAL DIMENSIONS

JØTUL F 602 - Page 28

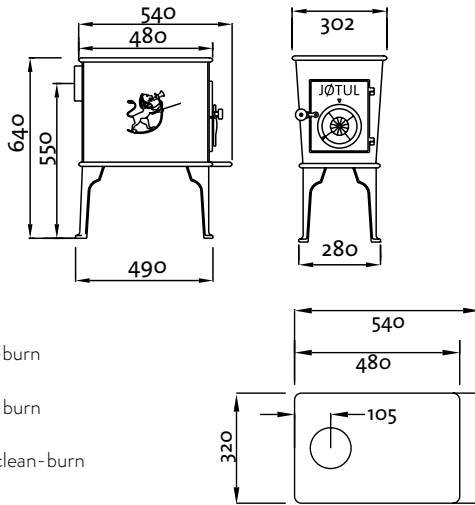

Catalogue Number:

- 30023115 Glass door - clean-burn (Blue-black enamel)
- 30023116 Glass door - clean-burn (Black paint)
- 30035801 Glass door - non clean-burn (Black paint)

- Finish Options:
- Matt Black paint (Standard)
 - Matt Black paint
 - Blue-black enamel (Cleanburn with glass door)
- Heat Output:
- Min 1 kW,
 - Rated 6 kW
 - Max 8.5 kW
- Maximum Log Length: 400 mm
- Flue Outlet: Top and rear
- Flue Size: 125 mm / 5" dia. (adaptor required)

Accessories:

- Adaptor to 5" (ADPT602)

JØTUL F 118 CB - Page 28

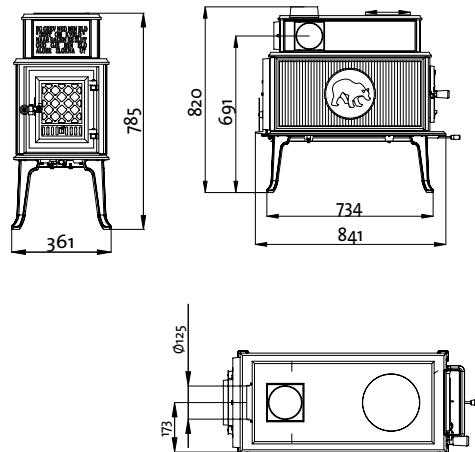

Catalogue Number:

- 30023117 (Black paint)

- Finish Options:
- Matt Black paint
- Heat Output:
- Min 4.0 kW,
 - Rated 7.0 kW
 - Max 11.0 kW
- Maximum Log Length: 600 mm
- Flue Outlet: Top, rear and both sides
- Flue Size: 150 mm / 6" dia. (adaptor included)

Accessories:

- Rear Heat Shield (50012879)
- Side Heat Shield (50012880)

JØTUL F 100 - Page 30

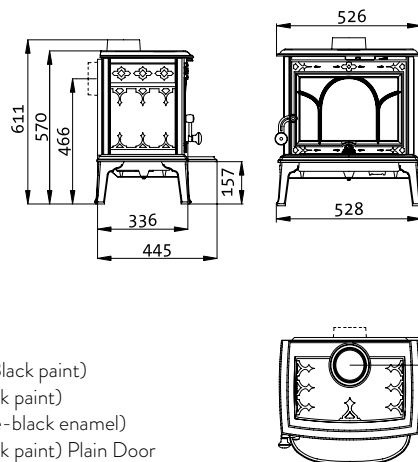

Catalogue Number:

- 30023205 Wood burner (Black paint)
- 30023203 Multi Fuel (Black paint)
- 30023204 Multi Fuel (Blue-black enamel)
- 30023221 Multi Fuel (Black paint) Plain Door
- 30049382 Multi Fuel (Ivory Enamel)

- Finish Options:
- Matt Black paint,
 - Ivory enamel (multifuel only)
 - Blue-black enamel (multifuel only)

- Heat Output:
- Min 2.7 kW,
 - Rated 5.0 kW
 - Max 7.5 kW
- Maximum Log Length: 400 mm
- Flue Outlet: Top and rear
- Flue Size: 125 mm / 5" dia.

Accessories:

- Multi-fuel Kit (51012219)
- Long legs - Black paint (51012223), Blue-black enamel (5102224)
- Ivory enamel (5102227)

General note for all stoves and fireplaces

1. Please note that the minimum heat output is achieved with the cleanburn system (where applicable) performing.
2. Please note that the rated output is based on laboratory achieved results when tested under DIN, EN or CE approval conditions.
3. Figures given for heat output are based on refuelling with wood every two hours. Outputs vary depending on the quality of the fuel used and refuelling periods.

JØTUL F 3, JØTUL F 3 TD, JØTUL MF 3 - Page 32

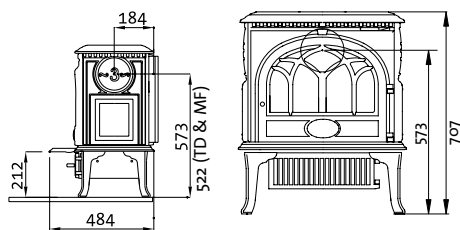

Catalogue Number:

- 30023172 Jøtul F 3 (Black paint)
- 30023173 Jøtul F 3 (Blue-black enamel)
- 30023174 Jøtul F 3 (Ivory enamel)
- 30023237 Jøtul F 3 (Majolica Brown enamel)
- 30023170 Jøtul F 3 TD (Black paint)
- 30023230 Jøtul MF 3 Multi Fuel Plain Door (Black paint)

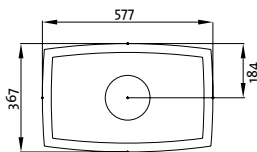

Finish Options:	Matt Black paint Blue-black enamel Ivory enamel * Majolica Brown enamel
Heat Output:	Min 3.4 kW / Rated 6 kW / Max 9.0 kW
Maximum Log Length:	460 mm
Flue Outlet:	Top, rear and side
Flue Size:	150 mm / 6" dia.

Accessories:

- Short Legs (155 mm) - available in all colours - (reduces the overall height by 65 mm)
 - Décor Rings - available in all colours
- * Top/rear exit only on ivory enamel (not side)
† For conversion of Jøtul F 3 TD only - all 3 items required

JØTUL F 8 - Page 30

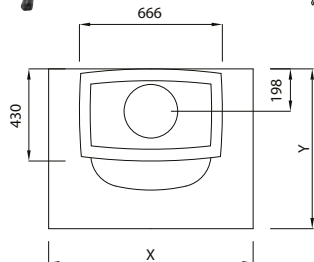
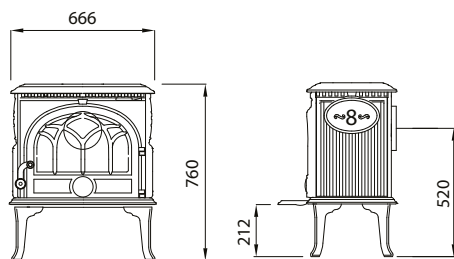

- Catalogue Number:
• 30023171 (Black paint)

Finish Options:	Matt Black paint
Heat Output:	Nominal approx 8.0 kW
Maximum Log Length:	460 mm
Flue Outlet:	Top / Rear
Flue Size:	150 mm / 6" dia.
Air system:	Air wash system and ignition vent
Combustion system:	Standard
Flue outlet:	Top and rear
Flue dimension:	150/175 mm dia.
Approx. weight:	Fireplace 115 kg
Heating area (headroom 2,4 m):	approx 135 m ²

JØTUL F 400 - Page 31

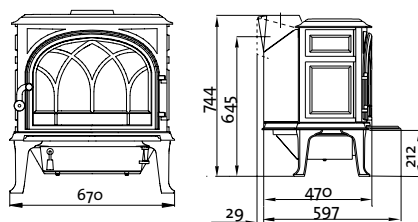

Catalogue Number:

- 30023207 (Black paint)
- 30023208 (Blue-black enamel)
- 30023209 (Ivory enamel)
- 30023238 (Majolica Brown enamel)

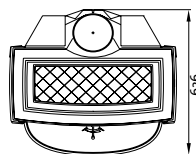

Finish Options:	Matt Black paint Blue-black enamel Ivory enamel Majolica Brown enamel
Heat Output:	Min 3.9 kW, Rated 7.5 kW Max 10.5 kW
Maximum Log Length:	500 mm
Flue Outlet:	Top and rear
Flue Size:	150 mm / 6" dia.

Accessories:

- Short Legs (155 mm) - available in all colours - (reduces the overall height by 65 mm)
- Outside Air kit (221031 + 51047509)

TECHNICAL DIMENSIONS

JØTUL F 500 - Page 31

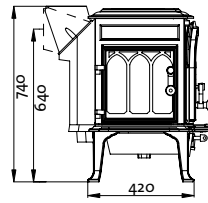
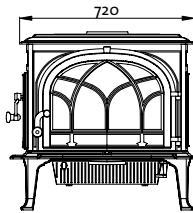

Catalogue Number:

- 30023181 (Black paint)
- 30023182 (Blue-black enamel)
- 30023183 (Ivory enamel)
- 30023273 (Plain door, Black paint)

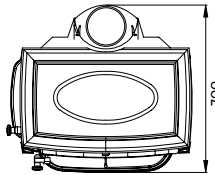

Finish Options: Matt Black paint
Blue-black enamel
Ivory enamel
Majolica Brown enamel
Majolica Green enamel

Heat Output: Min 4 kW
Rated 8.5 kW
Max 11.0 kW

Maximum Log Length: 550 mm

Flue Outlet: Top and rear

Flue Size: 150 mm / 6" dia.

Accessories:

- Outside Air kit (50012842)

JØTUL F 600 - Page 31

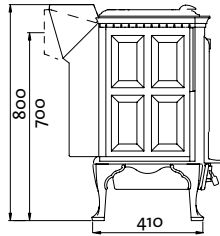
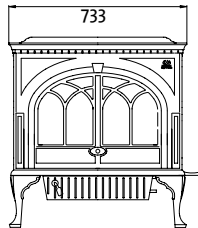

Catalogue Number:

- 30023214 (Black paint)
- 30023215 (Blue-black enamel)

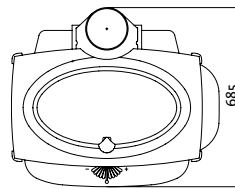

Finish Options: Matt Black paint
Blue-black enamel
Ivory enamel
Majolica Brown enamel

Heat Output: Min 3.5 kW
Rated 9.5 kW
Max 12 kW

Maximum Log Length: 550 mm

Flue Outlet: Top and rear

Flue Size: 150 mm / 6" dia.

Accessories:

- Outside Air kit (50012843 + 51012164)

JØTUL I 18 HARMONY, JØTUL I 18 PANORAMA - Page 44

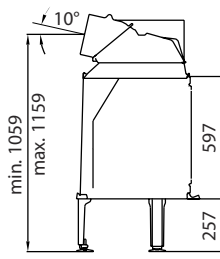
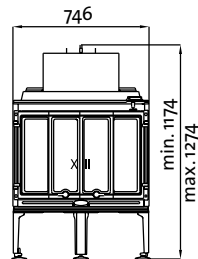

Catalogue Number:

- 30023121 Jøtul I 18 Harmony
- 30023120 Jøtul I 18 Panorama

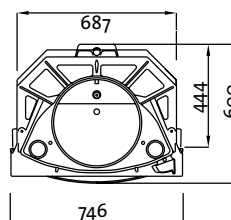

Finish Options: Blue-black enamel

Heat Output: Min 3 kW,
Rated 10 kW
Max 15 kW

Maximum Log Length: 500 mm

Flue Size: 175 mm / 7" dia. internal
200 mm / 8" dia. external

Door Styles: Harmony
Panorama

Accessories:

- Canopy, complete with side panels (190002)
- Firescreen (panorama model only)
- Decorative Plinth (190030)

JØTUL I 400 - Page 45

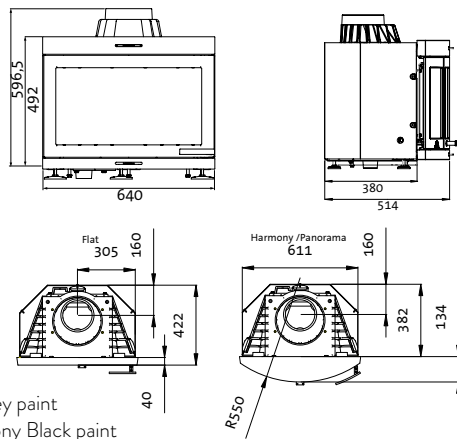

Catalogue Number:

- 30043683 Jøtul I 400 FL Grey paint
- 30023147 Jøtul I 400 Harmony Black paint
- 30023148 Jøtul I 400 Panorama Black paint

- Finish Options: Matt Black paint
 Heat Output: Min 3.7 kW
 Rated 6 kW
 Max 9.0 kW
 Maximum Log Length: 400 mm
 Flue Outlet: Top / Rear
 Flue Size: 150 mm / 6" dia. internal
 175 mm / 7" dia. external

Accessories:

- External air supply kit I400 (51012160)
- Ash solution I400 (51012161)
- Canopy – narrow (190400)
- Plinth (190401)
- Canopy – wide (190402)

CANOPIES & PLINTH JØTUL I 18, JØTUL I 80, JØTUL I 400 - Page 44

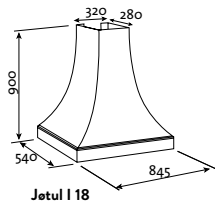
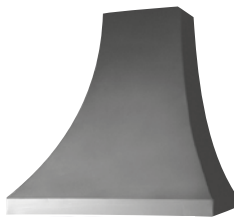

Jøtul I 18

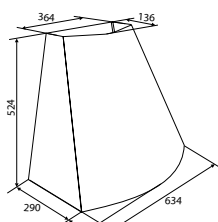

Jøtul I 400 narrow canopy

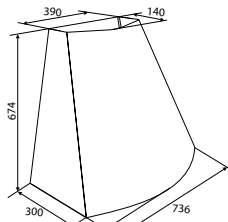

Jøtul I 400 wide canopy

Canopies are supplied complete with a set of matching side panels, and sprayed Matt Black with High temperature paint. Made to measure canopies are available at extra cost.

Decorative Base Plinth available for Jøtul I 18 and Jøtul I 400 Harmony and Panorama models.

Catalogue Number:

- 190002 to suit Jøtul I 18
- 190400 narrow to suit Jøtul I 400
- 190402 wide to suit Jøtul I 400
- 190030 Decorative Plinth for Jøtul I 18 Harmony and Panorama models. Height 80 mm.
- 190401 Decorative plinth for Jøtul I 400 Height 80 mm.

JØTUL C 24 - Page 45

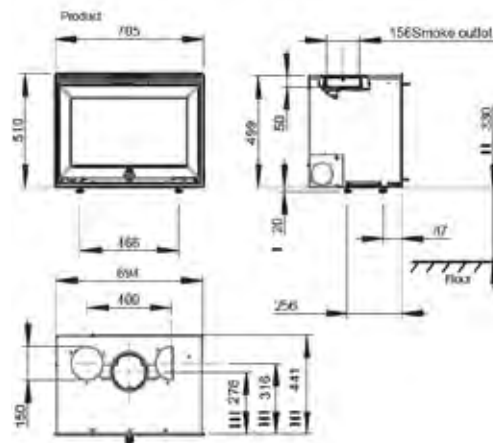

Catalogue Number:

- 30044102 Jøtul C 24

- Finish Options: Matt Black paint
 Heat Output: Min 4 kW
 Rated 7 kW
 Max 10 kW
 Maximum Log Length: 500 mm
 Flue Outlet: Top
 Flue Size: 150 / 6".

Accessories:

- Ash solution
- Riddling grate
- Outside air kit (100mm) (51012164)
- Tangential fan
- Wide frame
- Blower for C24 (50044779)

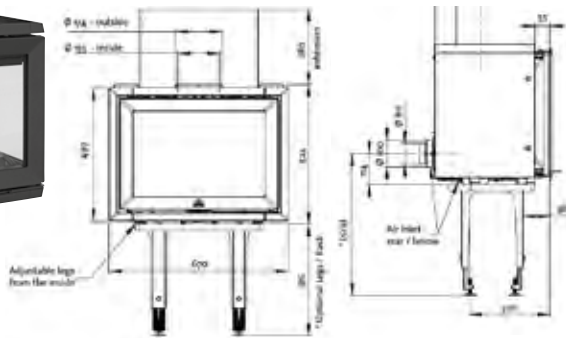

Catalogue Number:

- 30044743 Jøtul I 520 F Front glass
- 30044744 Jøtul I 520 FL Front and left glass
- 30044745 Jøtul I 520 FR Front and right glass
- 30044746 Jøtul I 520 FRL Front, right and left glass

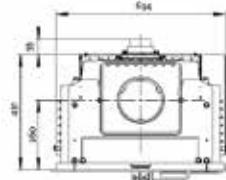

Finish Options: Matt Black paint
 Heat Output: Min 3.9 kW
 Rated 7 kW
 Max 10 kW
 Maximum Log Length: 500 mm
 Flue Outlet: Top and rear
 Flue Size: 150 / 6" dia.

Accessories:

- Leg rack complete (51044759)
- Convection top complete I 520 F (50045755)
- Dock lock complete left I 520 (right hinge) (50045754)
- Cassette grid I 520 F (50045747)
- Cassette grid I 520 FR (50045748)
- Cassette grid I 520 FL (50045749)
- Frame wide I 520 F 60 mm (50045750)
- Frame wide I 520 FL/FR 60 mm (50045751)
- Frame wide I 520 FRL 60 mm (50045752)
- Kit for outside air, 100 mm (std) (51012164)



Jøtul F 105 with long legs

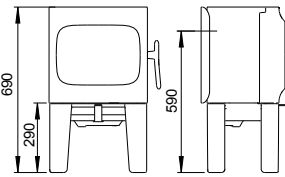

Jøtul F 105 long legs and soapstone top

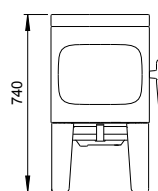

Jøtul F 105 with short legs and soapstone top

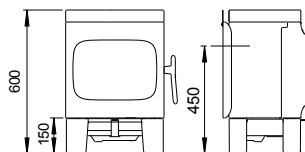
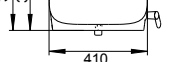

Jøtul F 105 with base

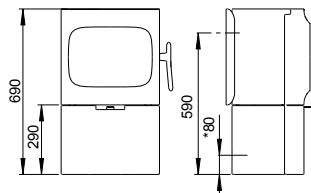

Jøtul F 105 with base and soapstone top

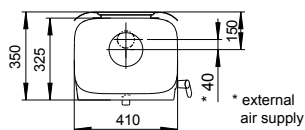
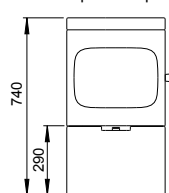

Finish Options: Black paint
 White enamel
 Heat Output: Min 2.4 kW
 Rated 4.5 kW
 Max 6 kW
 Maximum Log Length: 330 mm
 Flue Outlet: Top and rear
 Flue Size: 125 mm / 5" dia.

Accessories:

- Soapstone Top Plate (51049066)
- Kit for 80 mm connection to an external air supply (51047509)
- Handle for ashdrawer (51049070)
- Ash-lip (51049065 BP / 51049516 WHE)

Catalogue Number:

- 30048969 Jøtul F 105 LL Matt black
- 30045743 Jøtul F 105 SL Matt black
- 30046850 Jøtul F 105 B Matt black
- 30047346 Jøtul F 105 SL White enamel
- 30047345 Jøtul F 105 B White enamel
- 30048970 Jøtul F 105 LL White enamel

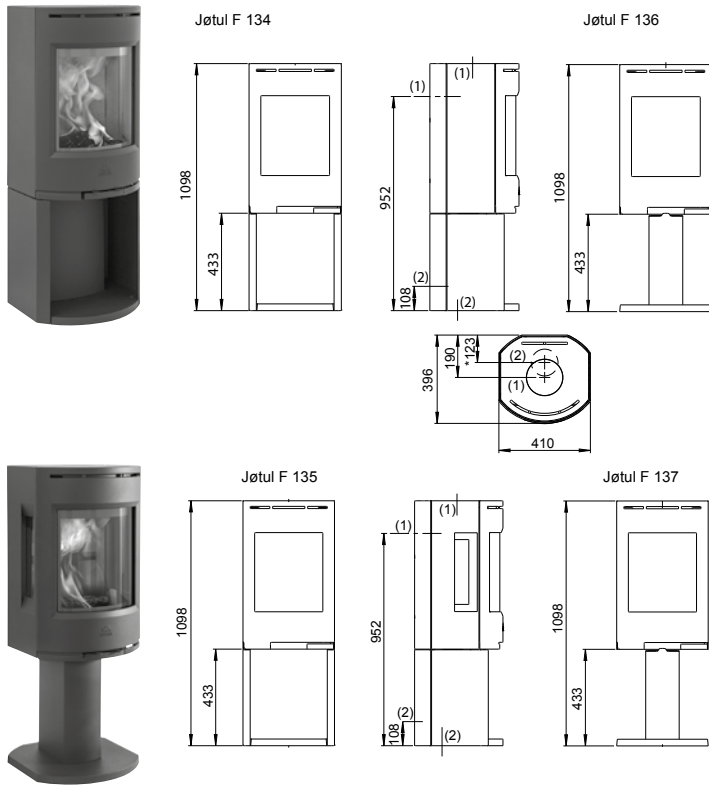

Finish Options: Matt Black paint
 Heat Output: Min 2.8 kW
 Rated 4.7 kW
 Max 7 kW
 Maximum Log Length: 300 mm
 Flue Outlet: Top and rear
 Flue Size: 150 / 6" dia.

Catalogue Number:
 • 30049161 Jøtul F134 Base BP without side glass
 • 30049128 Jøtul F135 Base BP with side glass
 • 30049160 Jøtul F136 Pedestal BP without side glass
 • 30049135 Jøtul F137 Pedestal BP with side glass

Accessories:
 • 50049584 Shaped Floor plate glass
 • 51049574 Shaped Floor plate steel
 • 51012164 Outside air kit

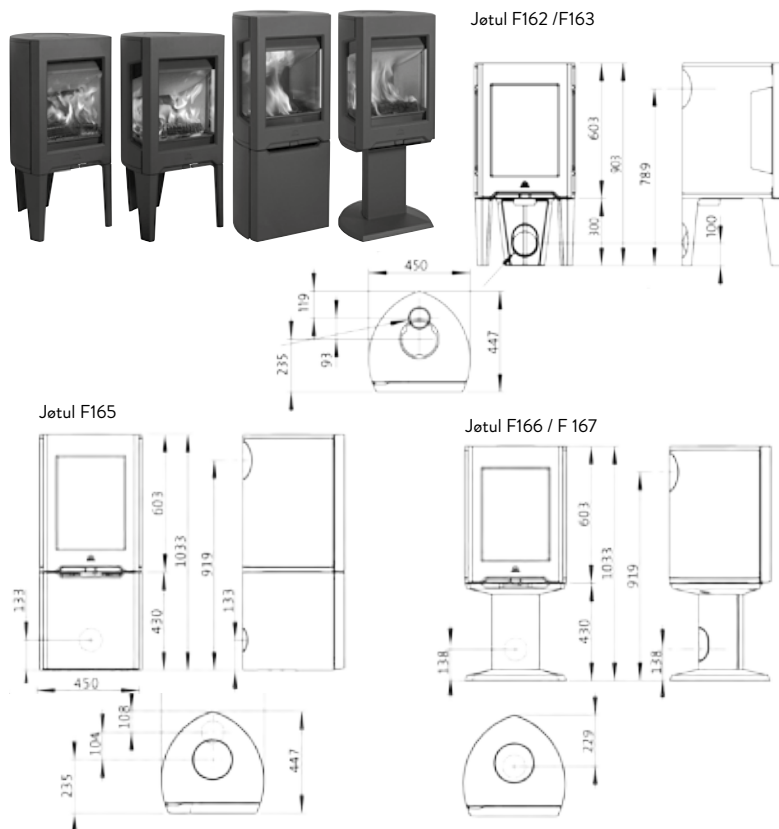

Finish Options: Black paint
 Heat Output: Min 3 kW
 Rated 5 kW
 Max 9.0 kW
 Maximum Log Length: 330 mm
 Flue Outlet: Top and rear (not Jøtul F 162 C)
 Flue Size: 150 mm / 6" dia.

Catalogue Number:
 • 30023263 (Jøtul F 162 Black paint)
 • 30023267 (Jøtul F 163 Black paint with side glass)
 • 351273 (Jøtul F 163 Black enamel)
 • 30036894 (Jøtul F 163 White enamel)
 • 30044116 (Jøtul F 165 Black paint with side glass)
 • 51044401 (Jøtul F 165 S Black paint with side glass and soapstone)
 • 30044529 (Jøtul F 167 Black paint with pedestal and side glass)

Accessories:
 • Soapstone top (361080)
 • Soapstone top Jøtul F 162 / F 163 (361080)
 • 100 mm short legs (BP only)
 • External air supply kit (341296)
 • Cover for legs when using external air supply (361083)
 • Convection top (361099)
 • Cover for ext air Jøtul F 162 / F 163 BP (51012329)
 • Connector top Jøtul F 162 / F 163 (50036913)

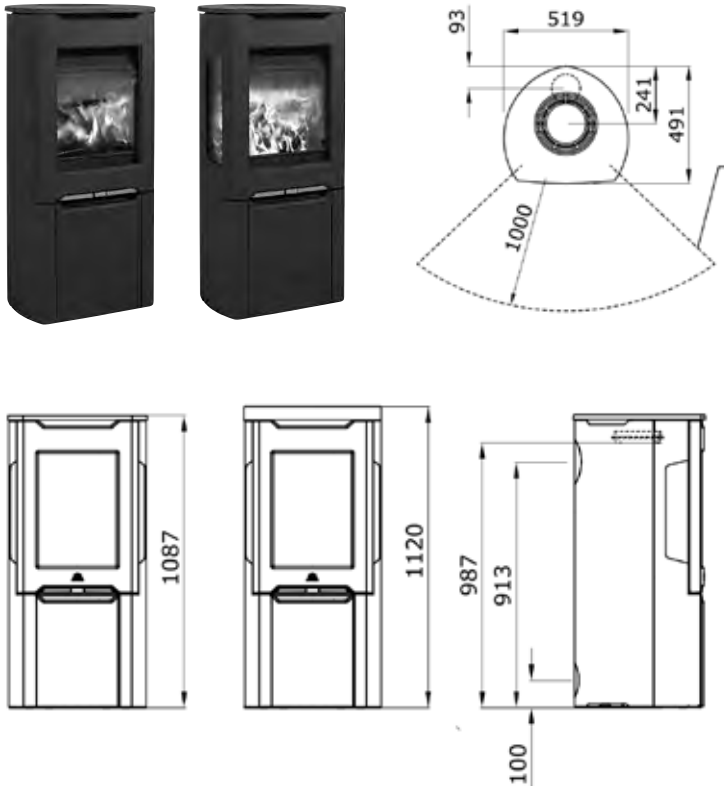

Finish Options: Black paint
 Heat Output: Min 3.7 kW
 Rated 5 kW
 Max 9.0 kW
 Maximum Log Length: 330 mm
 Flue Outlet: Top and rear
 Flue Size: 150 mm / 6" dia.

Accessories:
 • Soapstone Top Plate (50036901)
 • Fan for rapid heat (50036914)
 • Kit for connection to an external air supply (51012164)

Catalogue Number:
 • 351245 Jøtul F 262
 • 30023271 Jøtul F 263 with side glass

Must be ordered with steel side panel set (30023272) or soapstone panel set (50036877)

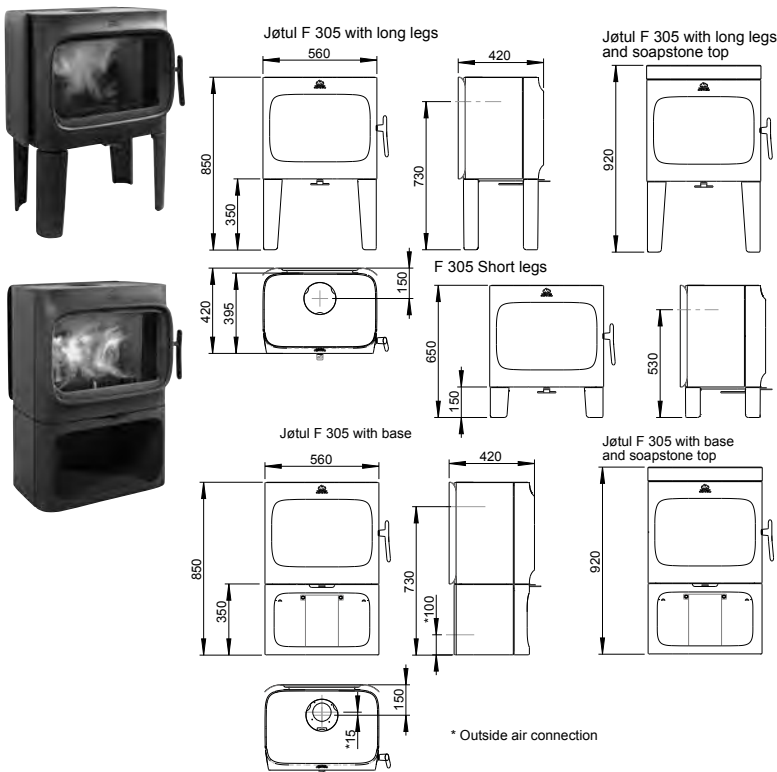

Finish Options: Black paint
 White enamel
 Heat Output: Min 3.7 kW
 Rated 7.0 kW
 Max 10 kW
 Maximum Log Length: 410 mm
 Flue Outlet: Top and rear
 Flue Size: 150 mm / 6" dia.

Accessories:
 • Soapstone Top Plate (51048022)
 • Floor plate in steel or glass
 • Kit for connection to an external air supply (51012164)
 • Short legs (BP 51047318 / WHE 51047340)
 • Ash-lip (BP 51047339 / WHE 51047341)

Catalogue Number:
 • 30044996 Jøtul F 305 LL Matt black
 • 30047335 Jøtul F 305 LL White enamel
 • 30046816 Jøtul F 305 B Matt black
 • 51047318 Jøtul F 305 SL Matt black (4 legs)
 • 51047340 Jøtul F 305 SL White enamel (4 legs)



**Jøtul F 371
Advance**

**Jøtul F 373
Advance**

**Jøtul F 377
Advance**

**Jøtul F 378
Advance**

Catalogue Number:

- 30050843 Jøtul F371 Advance (black paint plus cast iron open shelf base 51050937)
- 30050843 Jøtul F373 Advance (black paint plus black pedestal 51050940)
- 30050843 Jøtul F377 Advance (black paint plus black paint cast iron open shelf base 51050937 inc Soapstone set low 50043452, inc steel grid low 50050924)
- 30050843 Jøtul F378 Advance (black paint plus cast iron base 51050937 inc cast iron door 51050944)
- 51050944 Cast iron door for use with F371 HT, F377 and F377 HT

Finish Options: Black paint
 Heat Output: Min 3.9 kW
 Rated 5.9 kW
 Max 9 kW
 Maximum Log Length: 330 mm
 Flue Outlet: Top and rear
 Flue Size: 150 mm / 6" dia.

Accessories:

- Soapstone top
- Glass panels top, sides and front "rear flue" BP
- Glass panels top, sides and front "top flue" BP
- Pedestal Rotating Kit (360°)
- Steel decorative floorplate BP
- Outside air kit

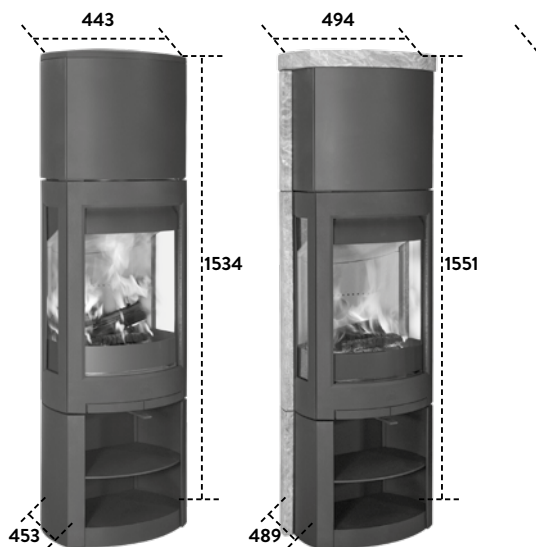

Jøtul F 371 High Top Advance Jøtul F 377 High Top Advance Jøtul F 378 High Top Advance

To Suit:

- Jøtul F 371
- Jøtul F 377
- Jøtul F 378

Catalogue Number:

- 30050843 Jøtul F371 HT Advance (plus cast iron open base 51050937 plus high top cast iron 51050934)
- 30050843 Jøtul F377 HT Advance soapstone, cast iron open base 51050937 (plus high top cast iron 51050934, plus soapstone high top 50043453, plus steel grill high 50050923)
- 30050843 Jøtul F378 HT Advance (plus cast iron open base 51050937 plus high top cast iron 51050944 plus high top cast iron 51050934)

Accessories:

- Heat Accumulating Stones Soapstone top

JØTUL F 373 WHE - Page 19

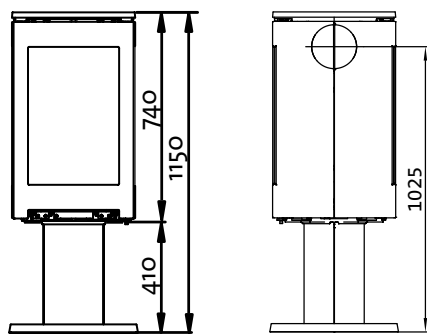

Catalogue Number:
 • 351374 White enamel

Finish Options: White enamel
 Heat Output: Min 3.5 kW
 Rated 5.5 kW
 Max 7 kW
 Maximum Log Length: 300 mm
 Flue Outlet: Top and rear
 Flue Size: 150 mm / 6" dia.

- Accessories:
- Soapstone top (51012988)
 - Glass panels top, sides and front "rear flue" BP (51012250)
 - Glass panels top, sides and front "top flue" BP (51012252)
 - Pedestal Rotating Kit (360°) (51012254)
 - Steel decorative floorplate BP (51013579)
 - Outside air kit (51012164)

350992 becomes 51012988
 350993 becomes 51012250
 350995 becomes 51012252
 350997 becomes 51012254
 351158 becomes 51013579
 341296 becomes 51012164

JØTUL F 481 / JØTUL F 483 - Page 27

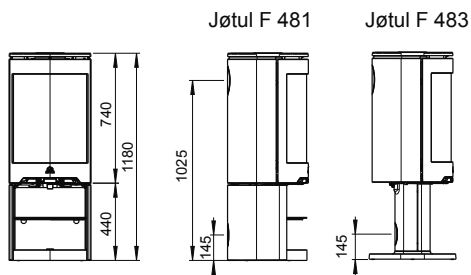

Finish Options: Black paint
 Heat Output: Min 3.5 kW
 Rated 6.0 kW
 Max 10.0 kW
 Maximum Log Length: 300 mm
 Flue Outlet: Top and rear
 Flue Size: 150 mm / 6" dia.

- Accessories:
- Floor plates in glass or steel
 - 80 mm kit for connection to an external air supply (51047509)

Jøtul F 483 with turntable

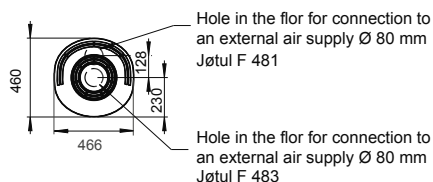
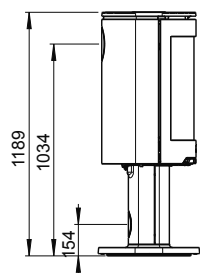

Catalogue Number:
 • 30047088/51047110/51047124 Jøtul F 481
 • 30047088/51047117/51047124 Jøtul F 483

JØTUL F 520 - Page 27

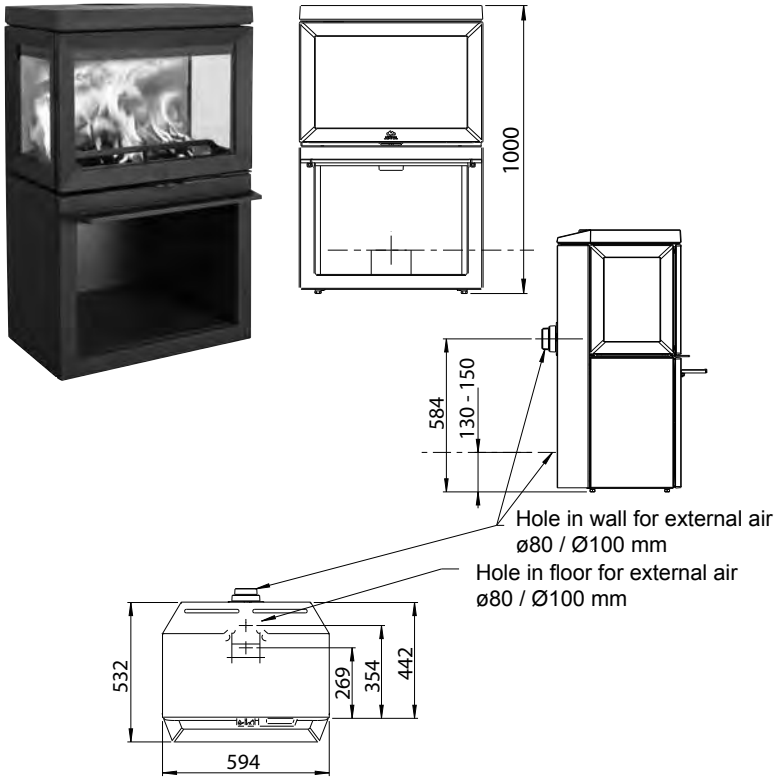

Finish Options: Black paint
 Heat Output: Min 3.5 kW
 Rated 7 kW
 Max 10 kW
 Maximum Log Length: 500 mm
 Flue Outlet: Rear
 Flue Size: 150 / 6" dia.

Catalogue Numbers:
 • 30049347 Jøtul F 520

Accessories:
 • 80 mm external air kit (51047509)
 • 100 mm external air kit (51012164)
 • Cover for outside air (51049688)
 • Floor plates glass/steel

JØTUL FS 73 / JØTUL FS 74 - Page 39

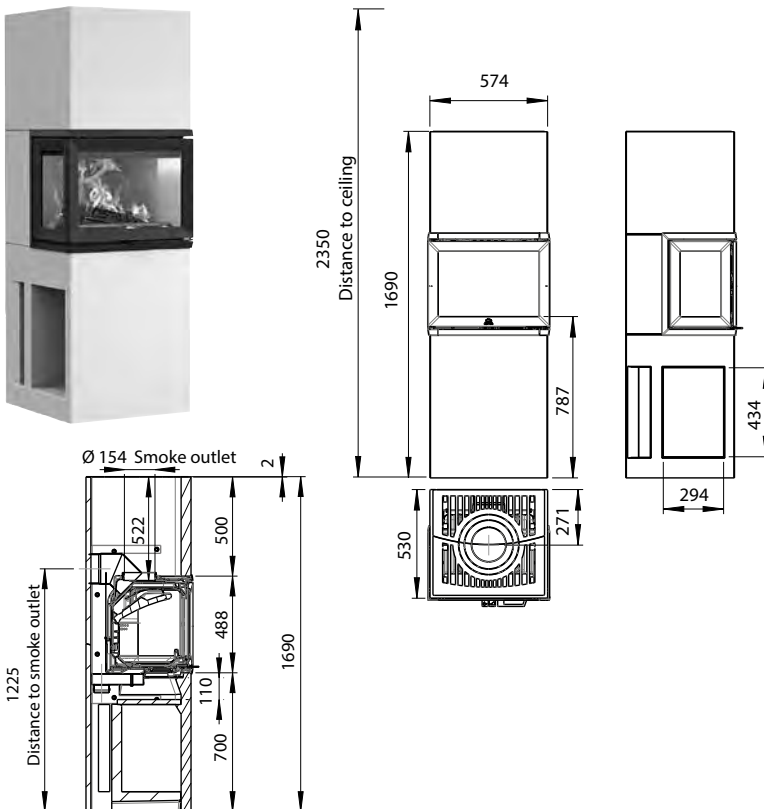

Black paint/lightweight concrete
 Inserts: Jøtul I 520 insert
 Heat Output: Min 3.9 kW
 Rated 7 kW
 Max 10 kW
 Maximum Log Length: 500 mm
 Flue Size: 150 / 6" dia.
 HxWxD (73) 1690x574x530 mm
 (74) 1690x574x600 mm

Catalogue Numbers:
 • 51046197 Jøtul FS 73 (530 mm deep)
 • 51046196 Jøtul FS 74 (600 mm deep)
 • 30044746 Jøtul I 520 FRL

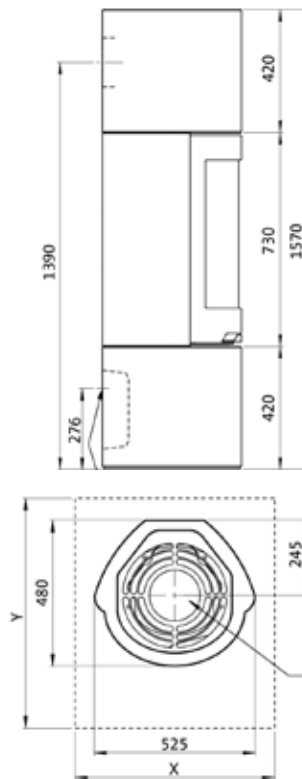

Finish Options: Delivered primed and ready for painting

Inserts: Jøtul 480 insert

Heat Output: Min 3.5 kW
Rated 6 kW
Max 10 kW

Maximum Log Length: 300 mm

Flue Outlet: Top and rear

Flue Size: 150 mm / 6" dia.

HxWxD 1570x525x480 mm

Catalogue Numbers:

- 30044643 Jøtul FS 91 Surround
- 30044644 Jøtul FS 92 Surround
- 30047088 Jøtul F 480 burn chamber

Accessories:

- Glass floorplate (50044652)
- Glass decor (50044653)

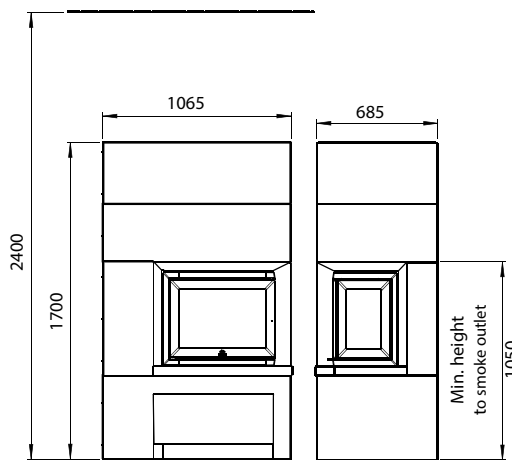

Finish Options: Black paint/lightweight concrete

Inserts: Jøtul I 520 insert

Heat Output: Min 3.9 kW
Rated 7.0 kW
Max 10.0 kW

Maximum Log Length: 500 mm

Flue Size: 150 / 6" dia.

HxWxD 1700x1065x685 mm

Catalogue Numbers:

- 30044745 Jøtul S71 FR
- 30044744 Jøtul S72 FL
- 30044745 Jøtul I 520 FR
- 30044744 Jøtul I 520 FL

Accessories:

- Floor plates in steel or glass (51047337/338)
- 100 mm outside air connection (51012164)
- Adapter for ventilated chimney (51046710)



General note for all stoves and fireplaces

The Gas Stove ceramic coal set and log sets are not interchangeable. Short Leg (155 mm) are available for the Jøtul GF 300 BF / GF 300 CF 2 in all colour options. Gas heat output could be effected by chimney or flue conditions. The information on gas stoves does NOT apply to Non domestic settings, which may require special advice with regards fluing. Although every effort has been made to ensure dimensions are accurate, Jøtul (UK) recommends that all apertures / holes needed for balanced flue system installation are first measured by offering up the stove and flue system prior to apertures / holes being made.

JØTUL GF 300 CF - Page 34



Jøtul GF 300 CF

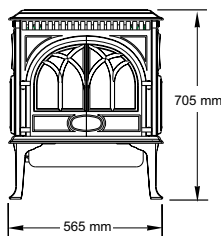

This height can be reduced by 65 mm when using short legs

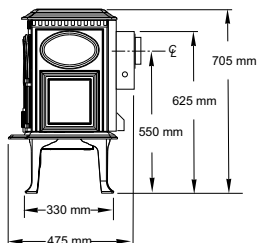

Jøtul GF 300 Catalogue Number:

- 351095 Matt Black paint
- 351096 Blue-black enamel
- 351097 Ivory enamel
- 351098 Majolica Brown enamel

Accessories:

- 155648 Antique effect brick panels
- 51012177 Short leg Black Paint
- 51012178 Short leg Blue Black Enamel
- 51012179 Short leg Ivory Enamel
- 51012279 Short leg Majolica Brown Enamel

Heat Input (Net kW):	Nat gas 6.3, LPG 6.3	
Heat Output Max (net kW)		Efficiency
Nat gas - rear flue	5.1 kW	80.6 %
Nat gas - top flue	5.0 kW	79.9 %
LPG - rear flue	5.1 kW	80.9 %
LPG - top flue	5.0 kW	79.5 %
Flue Outlet:	Top or Rear	
Flue Size:	125 mm	
Fuel Effect:	Log only	
Gas Types:	Natural Gas as standard with LPG conversion included	

Suitable for class 1 & 2 and precast flues to BS 1289 parts 1 & 2 as well as Closure Plate installations to BS 5871 parts 1 and BS 5440 part 1.

JØTUL GF 300 BF - Page 34



Jøtul GF 3 BF 3

Jøtul GF 300 BF

Please refer to installation manual for balanced flue terminal and pipe configurations & options. Manuals may be downloaded from the Jøtul website www.jotuluk.com

Finish Options: Matt Black Paint, Blue-Black enamel, Ivory Enamel, Brown Majolica enamel

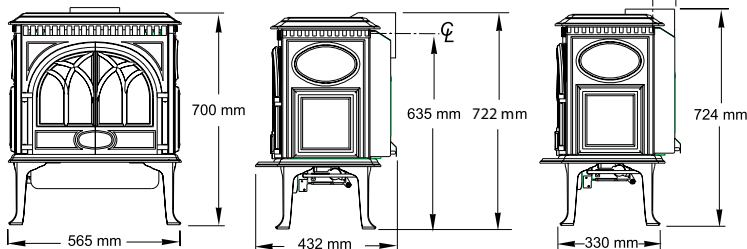

	Nat Gas	LPG
Max Heat Input (Gross)	7.5	7.5
Max Heat Input (Net)	6.8	6.9
Fuel Effect:	Log	
Gas Types:	Natural Gas/LPG	
Flue Outlet:	Top	
Flue Options:	Consult manual	

- Accessories:
- 155648 Antique effect brick panels
- GF 300 BF Catalogue Number:
- 351405 Matt Black
 - 351406 Blue-black enamel
 - 351407 Ivory enamel
 - 351408 Brown Majolica enamel

Efficiency(net)	Efficiency (% net)	Max Heat Output (kW net)	Configuration*
Nat Gas - rear flue (100/150 mm flue size)	76.6	5.2	45° Spigot + 325-400 mm Adjustable Length + 90° Bend + 100/150 Wall Terminal (c/w 600 mm length attached to terminal) (vent limiter position D)
Nat Gas - top flue (100/150 mm flue size)	73.3	4.9	45° Spigot + 100/150 Roof Terminal (+ vertical rise up to 10m) (vent limiter position A)
LPG - rear flue (100/150 mm flue size)	78.2	5.4	45° Spigot + 325-400 mm Adjustable Length + 90° Bend + 100/150 Wall Terminal (c/w 600 mm length attached to terminal) (vent limiter position D)
LPG - top flue (100/150 mm flue size)	74.4	5.1	45° Spigot+100/150 Roof Terminal (+ vertical rise up to 10m) (vent limiter position A)

JØTUL GF 373 BF - Page 35



Catalogue Number:

- 351373 Matt Black paint
- 351374 White enamel

Now includes mirror panels and flue spigot as standard.

Please refer to installation manual for balanced flue terminal and pipe configurations & options.

Manuals may be downloaded from the Jøtul website www.jotuluk.com

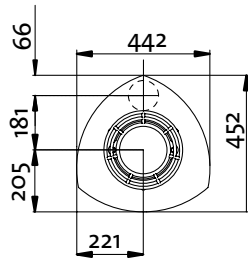
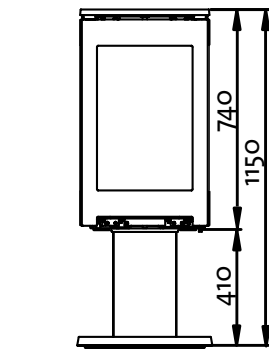

Finish Options:	Matt Black paint White enamel
Heat Output Nat Gas:	5.7 kW Net
Heat Output LPG:	5.5 kW Net
Efficiency max. Nat Gas:	82.2 %
Efficiency max. LPG:	78.4 %
Fuel Effect:	Log
Gas Types:	Natural Gas LPG
Flue Outlet:	Top or top then rear

Accessories:

- M82650 300 mm vertical terminal
- M82652 600 mm horizontal terminal
- M82653 500 mm fixed length
- M82654 1000 mm fixed length
- M82655 500 mm cutable length
- M82668 325-440 adjustable length
- M82656 90 degree bend
- M82657 45 degree bend x 2
- M82668 325-440 adjustable length
- M82661 locking band
- M82667 wall thimble
- M87196 wall bracket
- M87379 vertical flat roof flashing
- M87913 vertical pitched roof flashing
- M30170 heat shield
- GUARD Horizontal flue guard

JØTUL GF 400 CF - Page 34

* Consult manual for flue configuration and flue limiter positioning

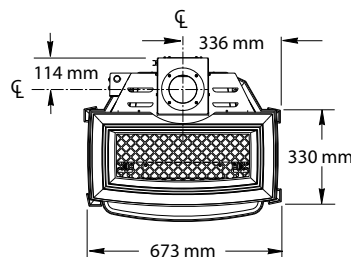
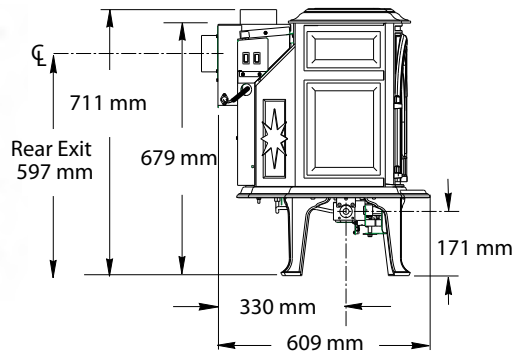

Catalogue Number:

- 351060 Black paint
- 351061 Blue-black enamel
- 351064 Majolica brown enamel

Finish Options:	Matt Black paint Blue-black enamel Majolica Brown enamel
Heat Input NG:	8.7 kW
Heat Input LPG:	9.3 kW
Heat Output NG:	6.8 kW
Heat Output LPG:	7.2 kW
Efficiency:	77.9 %
Fuel Effect:	Log only
Gas Types:	Natural Gas LPG
Flue Size:	125 mm
Flue Outlet:	Top/Rear

Accessories:

- Antique effect brick panels (155375)



CLEAN BURN

This means that fireplace has a dual combustion system that converts up to 90% of the gases and particles in smoke to heat. This provides the absolute minimum level of smoke emission because the fireplace uses the energy to give heat instead of smoke.



CLOSED COMBUSTION

Products with closed combustion system takes air through a separate air channel directly from the combustion chamber and through an outside wall or through the floor.



CLASS 1 - TESTED FOR HOUSES WITH LOW ENERGY

When a wood stove is approved as a "Class 1" means it can burn cleanly and efficiently at a significantly lower power than conventional wood stoves. It is clean burning with a wood consumption at 0.8 kg per hour or less. This is lower than what is considered normal for a clean-burning wood stove.



40 % LESS WOOD

Modern wood stoves have 40 % more efficient combustion and 90 % fewer emissions than old fireplaces.



DEFRA EXEMPT

Department for the Environment, Food & Rural Affairs. Exempt stoves are models that are cleared to burn specialised fuels in smoke control areas, fuels that would normally be disallowed. Many of our new ranges, such as our Cleanburn range of stoves, are designed and fitted with technology that means wood can be legally burnt within a smoke control area.

JØTUL
FIGHTING THE COLD SINCE 1853

